

EventPlayer

MP3/Wav/DMX Player

MANUAL

Table of contents

A - Safety instructions	P1
B - Product information	P3
1 - Product presentation	P4
2 - Fonctionnalités	P4
3 - Installation	P6
4 - Operation mode and naming of files	P9
5 - Configuration file	P16
6 - USB Link	P21
7 - USB HOST Link	P21
8 - DMX Link	P22
9 - Auxiliary input	P22
10 - Input / output contacts	P23
11 - Ethernet Link	P24
12 - Serial RS232 Protocol	P31
13 - Reset Factory	P34
Annex A : Binary table	P35
Annex B : Specifications	P36
Annex C : Function	P37
Annex D : Infrared remote control	P38

ID-AL products are exclusively manufactured by Waves System

LA VILLE EN BOIS - 44830 BOUAYE - FRANCE

Sales and information: +33 2 40 78 22 44

E-mail : info@id-al.com

Web site: <http://www.id-al.com> and www.wsystem.com

Technical department : support@wsystem.com

Technical support :

For a detailed list of the technical support options, we suggest you to visit our site www.id-al.com.

Information in this manual is subject to change without notice and do not represent any commitment from Waves System. The equipment described in this manual is supplied under condition of the terms of license specifying the legal use conditions. This manual can't be reproduced or used, in whole or in part, in any form and by any mean, for other use than private, without the written permission from Waves System.

ID-AL is a trademarks of Waves System.

CAUTION! DO NOT EXPOSE TO HUMIDITY & DUST!

Unplug the power supply cable before any servicing

FOR YOUR SAFETY, PLEASE READ THE USER'S GUIDE CAREFULLY BEFORE OPERATING YOUR PLAYER.

A. SAFETY INSTRUCTIONS

A.1 CE marking

The CE marking is found on the nameplate, at the rear side of the device. It certifies the conformance of the device with the low voltage CE Directive, according to the EN 55022 standard, and the Electromagnetic Compatibility Directive 61000-4-x.

A.2 Directives

- The requirements related to the electromagnetic compatibility and low voltages directive are met.

A.3 Overview

- The user manual is an integral part of the product. It must always be kept handy & close by. Proper usage conforming to the product intended purpose involves strict compliance with the instructions given in this manual.

In the event of return of the equipment, the user manual should be handed over to the new purchaser. The staff should receive instructions concerning the proper usage of the device.

- Only usage of genuine parts ensures perfect safety for the user and correct operation of the device. Moreover, only accessories mentioned in the technical documentation or explicitly approved by the manufacturer must be used. In the event of usage of accessories or consumable products from other brands, the manufacturer cannot stand guarantee for the correct and safe operation of the device.
- Damages caused through usage of accessories or consumable products from other brands will not entail right to any benefit under the terms of warranty.
- The manufacturer will be liable for the safety, reliability and functioning of the product as long as the assembly, settings, modifications, extensions and repairs have been carried out by the manufacturer or a company approved by the manufacturer and if the device is used in accordance with the instructions mentioned in this manual.
- The player complies with the technical safety standards in force at the date of print of this manual. All rights reserved for the electrical diagrams, procedures, names and devices mentioned herein.
- Any reproduction of the technical documentation, even partially, without the written authorization from Waves System is prohibited.

A.4 General Safety instructions

This device has been shipped out from our facilities in perfect working condition. In order to preserve these conditions, for safety and to avoid any risk of accidental bodily injury, the user must imperatively follow the safety instructions and read the 'Caution!' messages included in this manual.

This device, made by Waves System, has been designed in a way that practically eliminates any risk if it is used in accordance to its intended purpose. Nevertheless, with a concern for safety, we would like to draw your attention to the following instructions:

- When using the device, comply with all local rules and regulations in force. Any modification or

conversion of the device automatically entails loss of the homologation. The operation of a modified device is liable to a penalty. In the interest of occupational safety, the operator and the user are held responsible for complying with the regulations.

- Keep the original packing for a possible product re-shipment. Also ensure to keep the packing material out of children's reach. Only this original packing ensures optimal protection for the product during transportation. If a product reshipment appears to be necessary during the guarantee period, Waves System is not liable for any ensuing damages arising during the transportation and attributable to a defective packing.
- This device is used to broadcast audio files. It should be used only by persons whose training or knowledge ensures proper handling.
- Before every use, the operator must check that the device is in perfect working condition.
- This product must not be used in places where there is a potential explosion risk. Besides, it must neither be used in an environment favouring combustion nor in a humid or excessively hot or cold location.

A.5 Safety instructions against risks due to electric currents

- The device must be connected to a grounded AC power outlet or a European standard outlet installed as per good professional practices.
- Before connecting the device, check that the power supply voltage and frequency match the specifications indicated on the device.
- Before powering, check that the device and cables are not damaged. Damaged cables and connections must immediately be replaced.
- Never allow the power cords to come in contact with other cables. Handle the power supply cable as well as all other cables connected to the mains with extreme care.
- Always connect the plug-in connector in the end. Ensure that the On/Off switch is in 'Off' position before connecting the device to the mains. The mains outlet must remain accessible after the installation.
- Check the device and its power supply cable from time to time. Disconnect the device from the mains when it is no longer used or for the purpose of maintenance.
- Handle the power cord by using the plug-in connector only. Never remove the plug-in connector by pulling the power cord.
- Electrical connection, repairs and maintenance must be carried out by qualified personnel.
- Do not switch on or switch off the device within a short span of time as this will reduce equipment life.

A.6 - Terms of use:

- This product has been designed for indoors use only.
- If this device has been exposed to very high temperature fluctuations (e.g.: after transportation), do not connect it immediately. The condensation formed inside the device could damage it. Allow the device to attain ambient temperature before connecting it.
- Do not shake the device, avoid sudden movements during its installation or handling.
- When selecting the spot for installation of the player, ensure that it is not exposed to a high source of heat, humidity or dust. There should not be any cables lying around as they might jeopardise your & others safety.

B. PRODUCT INFORMATION

B.1 Correct usage

The player is used to broadcast audio files automatically.

Correct usage involves compliance with the instructions given in this manual as well as with the requirements concerning installation.

B.2 Incorrect usage

Any other usage or usage beyond the scope of this application is considered as incorrect usage. The manufacturer shall not be liable for the damages ensuing from it. The user shall bear full responsibility for the risks incurred.

B.3 Delivery details

EventPlayer

External power supply and its power supply cable

User's manual

B.4 Specifications

Audio Player- EventPlayer Model - AP303v2

Nominal electrical values of the power supply connection

Voltage (V) 100 to 240

Frequency (Hz) 50-60

For details see Annex B

B.5 Installation

The device must be installed in a dust free area.

Do not install the device directly against a wall. To avoid overheating, the ventilation openings must not be blocked. Take care to leave an empty space above the ventilation slits.

B.6 Electrical connection

Before activation, check whether the mains voltage matches with the voltage indicated on the rating plate.

1 - Introduction

EventPlayer AP303v2 is a WAV & MP3 format audio files player providing Show Control function. The files are stored on a SD Card or USB device, stick or hard disk. This standalone player can read files automatically according to a broadcast schedule or upon triggering by external events.

The Show Control function consists of sending commands to the 8 output contacts, programmed values to the DMX channels or/and instructions through the serial link in synchronisation with the audio.

EventPlayer is used in sound & light shows, event driven industry, monuments displays, audio automation and integration projects for museums, exhibitions, retail, theme parks & tourist attractions...

2 - Features

Interactivity: EventPlayer is an interactive player.

- Broadcast pattern defined by file names
- Electrical contacts: 8 inputs combinable up to 255 inputs to trigger files through sensors, push-buttons, relays ...
- Commands through the RS232 serial link. A simple protocol is used to send commands to the player.
- Commands via a web page through the Ethernet link.
- Time programming. Integrating an real time clock, the player broadcasts files according to a schedule created using the "ID-AL Scheduler" software.
- An built-in infrared sensor allows remote control (optional ID-AL handset available).
- A keyboard or a USB numeric keypad can be connected on the To Host front panel connector to broadcast files associated to specific keys.

Autoplay: EventPlayer starts automatically on powering on. This feature is programmable and can be disabled.

Playback: The audio files are stored on a SD card or an external USB device. The playback pattern is defined by file & directory names.

Updating: The SD card or USB stick can be removed easily for updating using a computer. It is also possible to connect a computer to the USB port or through the Ethernet link (FTP mode) of the player in order to access content of the storage device and carry out copy & delete operations.

Audio output: 3 types of outputs are present:

- A line level stereo audio output on a RCA standard connector
- An S-PDIF stereo digital audio output on a RCA standard connector
- An amplified stereo output on a removable terminal block.

Audio input: The player offers a line level auxiliary audio input on RCA standard connector. The input is switchable through triggering and programming. The player acts like a message box inserted in an existing sound system. A Fade in/out is programmable to ensure a smooth transition.

Show Control: The player can play audio files, event files, or both at the same time in synchronisation. The event files are made of commands sent to the various outputs:

- 8 outputs on optocoupler to action relays, motors, lamps ...
- data sent to the DMX link to control dimmers, projectors with LED or gen-locks, lyres ...
- data sent through the serial link RS232 (activation of a video projector, command to a PLC ...)

The show sequences are created on a computer using the ID-AL "Show Control Editor" software. The event files created by the software are then copied into a memory card to be read by the player the same way as audio files.

Power supply: 2 power supply sockets are available at the rear side of the player. The 2 sockets are wired in parallel. This means that the power supply unit can be connected on any one of the 2 sockets indifferently. The second socket helps to carry over the incoming power supply to a second EventPlayer, sensors or any other device using the same voltage. The player is protected against polarity reversals and against usage by mistake of an alternative power supply instead of the D.C. power supply. Caution! The player can bear a tolerance of the power supply voltage between 10 & 15V. Beyond this voltage range, the player can be damaged.

The power output of the amplifier depends on the mains power. When the line output is used, a power supply of 500mA (6W) is sufficient to operate the player. When the amplified output is used, a power supply unit of at least 3.45A (45W) is essential. If an inadequate power supply unit is used, there is a risk of obtaining very poor sound and of overheating PSU leading to a break-down.

3 - INSTALLATION

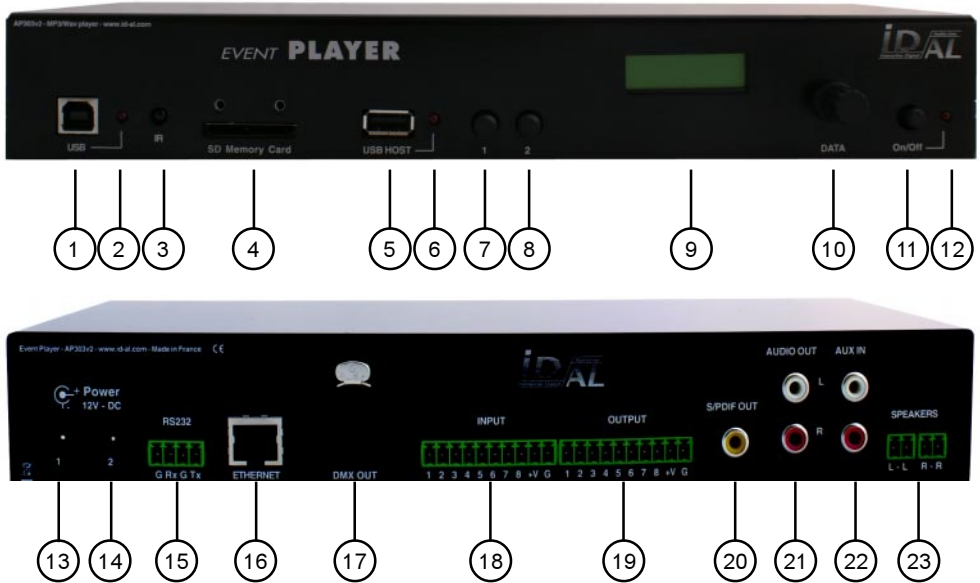

- 1 - USB port - For SD card update only
- 2 - USB connection indicator
- 3 - Infrared sensor
- 4 - Slot for the SD memory card
- 5 - Host USB port - Connection for USB device, stick, hard disk, keyboard...
- 6 - USB HOST connection indicator
- 7 - Customisable button No.1
- 8 - Customisable button No.2
- 9 - LCD display
- 10 - Set-up button
- 11 - Play/Stop button
- 12 - Power indicator

- 13/14 - Power supply - a second socket to power another device
- 15 - RS232 serial link
- 16 - Ethernet link
- 17 - DMX output
- 18 - Dry contact Inputs
- 19 - Outputs on opto-coupler
- 20 - Co-axial S/PDIF digital audio output
- 21 - Line level output
- 22 - Line level auxiliary input
- 23 - Amplified output for speakers

First use: The EventPlayer is factory set with default parameters. The following settings need to be carried out before using the player for the first time.

- 1 - Switch-on the player by pressing the play/stop switch (11).
- 2 - After initialisation, press the "Data" button (10) to enter the set-up menu.
- 3 - Turn the button to display the desired menu and confirm choice by pressing the button.
- 4 - Exit the menu or a sub-menu by turning the button till it displays "Exit" or "Return" and confirm choice by pressing the button.

See annex for the list of associated settings and possible values.

Memory card: Select a quality SD card. Insert the card into its slot to the stopper without forcing it. To remove it, press gently on the card.

USB To Host connector: To this port you can connect a USB device, stick, hard disk...

Note: If a SD card and a USB stick are both connected, the SD card will be given priority and the USB stick will not be used.

Generally, new SD cards or USB sticks are formatted in "FAT" or "FAT32".
If you must format a card or a stick, select the FAT or FAT32 format depending on memory size. (FAT32 above 512Mb) **Other types of formatting do not work.**

The new hard disks are not formatted. You must create a partition and format the disk before any usage.
Select FAT32 format. Other types of formatting do not work. Some utility programs are available to carry out this operation from your computer (including some freeware).

To this port, it is also possible to connect a standard computer keyboard to use it like a remote control to open files or trigger some actions. See related chapter.

Power supply unit: We recommend to use the PSU supplied with the player. If you want to power your player from another power supply unit or from a battery, it must be in 12V DC although the player can operate between 10V & 15V. The power consumed depends on the power level of the amplifier.
Connect the power supply to either one of the sockets convenient to you. The second socket is connected in parallel enabling powering of another device.

USB port: When you connect a USB cable between the EventPlayer and a computer, the player goes to USB mode. Then, the computer loads up the standard "Mass Storage" driver to display content of the memory card. You can then use a file manager such as Windows Explorer to copy, move, rename & delete files.

Volume control: Turn the DATA button to change the volume. It is also possible to configure the two buttons "1" and "2" to control the volume. See the chapter "menu & configuration". In this case, press the buttons 1 (volume -) and 2 (volume +) to change the volume.
Caution! The volume can also be changed through the serial link, Ethernet & the file name.

RS232 Serial link: The EventPlayer can be operated through a PLC, a computer or a remote control using the serial link. The player receives information on its Rx input and sends information on the Tx output. A specific protocol is provided in this manual.

Dry contact inputs: you can connect push buttons, presence, light and smoke detectors, heat sensors, pressure probes... to the relays to trigger the player if a specific event occurs. See the usage description in this manual. Briefly make contact between one of the 8 inputs marked from 1 to 8 and the ground G. You can also combine the 8 inputs to obtain up to 255 possibilities. In this case, it is recommended to use a diodes or external control electronics. For more details, see annex.

Outputs on optocoupler: Connect relays, LED, an electronic controller, PLC, wireless remote contact... in order to operate these elements through the player. See the description for usage in this manual.

Caution! The output power is limited. To operate high power devices, you must use a command interface. For more details, see annex.

DMX output: The DMX protocol is used in lighting control. You can connect any equipment compatible with the DMX512 standard such as dimmers, mono or multi colour LED projectors, lyres, DMX to relays converters, servomotors...

Ethernet: This standard RJ45 connector, allows connection of the device to a 10/100 basic computer network. Thanks to the integrated Web Server, a computer connected on a network or internet and navigation software like "Internet Explorer" or "Firefox", will allow you to control the player: play / stop a file, enable / disable output, control volume, change parameters ...
The integrated FTP server provides access to the memory card or USB device to copy, edit, and delete files.

Analog audio output: Connect the stereo output to an amplifier, a sound system, an audio mixer or any other audio equipment having a line level input (CD player type).

Digital audio output: On this socket, connect an audio broadcast system equipped with a coaxial S/PDIF format input.

Speaker output: EventPlayer has an internal amplifier offering the option of connecting speakers, Hi-Fi speaker systems or sound system. Connect the 2 terminals of the speakers to the 2 outputs of each channel.

Caution: Never interconnect the outputs, do not short-circuit and do not connect speakers whose impedance is lower than that recommended in the specification of the player.

4 - Operating mode and naming of files

Compatible files:

- .MP3: MP3 format audio files (see specification in annex C)
- .WAV: WAV format audio files (see specifications in annex C)
- .SC2: "Show control" sequence files created by the IDAL Show Control Editor software.

The file names and directories define the playback mode. The files must be stored according to a specific organisation described below.

4.1 Organisation of the directories:

Only ONE directory level is allowed at the root. The directory names are made of 3 digits (000 to 999) followed by optional parameters and a name of your choice.

Example :

- 001
- 003 [J002]
- 034 directory name
- 247 [R001] [SEQ] my directory

● **The first three digits represent the directory No. and thereby its main name.**

Example :

- 000 : Directory N°000 - "Autoplay" directory which is automatically played when the device is powered-on
- 001 : Directory N° 001
- 034 : Directory N° 034

The directory number is used to define the playback sequence, it identifies the directory when a directory jump is required and on triggering of an input. You can use any number between 000 & 999.

IMPORTANT: The 8 input contacts allow trigger of directories identified by these 3 digits, as per a binary sequence from 001 to 255 (See table in the annex).

- Input 1 : Directory 001
- Input 2 : Directory 002
- Input 3 : Directory 004
- Input 4 : Directory 008
- Input 5 : Directory 016
- Input 6 : Directory 032
- Input 7 : Directory 064
- Input 8 : Directory 128

The simultaneous use of several input contacts offers up to 255 different combinations. No. 001 to 255 corresponds to the 8 input contact combinations.

Special case: Directory 000 is the directory which will be played by default on powering on. On powering on, presence of this directory is checked ; if it is present, the player plays files of this directory. If this directory is missing, the player switches to sleep mode.

Note: The directory which is read by default on powering on can be modified in the configuration menu.



Optional parameters

To modify the behaviour of the player, you can add optional parameters to the directory name. These parameters are boxed with the "[" "]symbols. You can add several parameters to the directory name.

[Jxxx] - Jump to another directory after reading the current directory.

[AUX] - Switch the player on the auxiliary input after reading the current directory.

[RET] - Returns to the previous directory after reading the current directory.

[RND] or [SEQ] - Specifies random or sequential playback mode for the current directory.

[Rxxx] - Action output contacts.

V+xx] or [V-xx] - Controls the volume level of the directory.

Note: If no optional parameter has been indicated, the player reads randomly the current directory in full and stops.

- **[Jxxx] - Names the directory No. to JUMP to after reading the current directory.**

By adding this parameter to the directory name after the directory No., you define the behaviour of the player after reading the current directory so that it starts reading another directory or loop in this directory.

Example:

xxx [J002]: Jump to directory 002 after reading directory xxx

001 [J023]: Jump to directory 023 after reading directory 001

034 [J034]: Jump to directory 034 after reading 034 -> Loops in directory 034

xxx represents a directory number between 000 & 999

- **[AUX] - Selects the auxiliary input after reading the current directory.**

EventPlayer has an Auxiliary audio input. To this input, a sound source such as a satellite receiver, computer, another audio player ... can be connected. The EventPlayer controls the main source to broadcast programmed messages, news, jingles...

The player can be used to broadcast local information or as a backup system.

By a program or trigger (by input contact, Ethernet or serial link ...) the audio program which enters via the auxiliary socket is interrupted with a fade-out and the selected directory is played. If the Auxiliary input is selected again, the initial audio broadcast starts again with a fade-in.

To return from the auxiliary mode and read a directory, it is necessary to launch an action on one of the inputs, a scheduled program or a RS232 command, via Ethernet or a programmed button on the front panel.

Example:

001 [AUX]: Reads directory 001 and then switches to the Auxiliary input

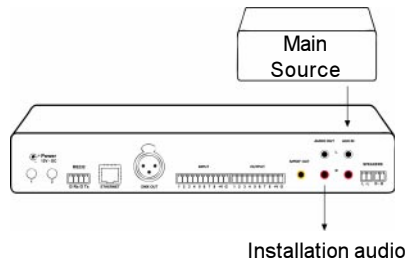

● **[RET]** - Returns to the previously read directory after reading the current directory.

If you read files in a particular directory and if it is interrupted by a scheduled program or an external action to broadcast a file from another directory, goes back to the initial directory after reading the triggered directory.

Example:

002 [RET]: Reads directory 002 and then goes back to the previous directory

- Several directories can point to the same directory then goes back to calling directory.

Example:

001 [J100]: After reading directory 001, jumps to directory 100

002 [J100]: After reading directory 002, jumps to directory 100

004 [J100]: After reading directory 004, jumps to directory 100

100 [RET]: Returns to the previous directory (001 or 002 or 004)

In the above example, after reading directories 001, 002 and 004, jump to directory 100 and then goes back to the initial calling directory after reading directory 100.

● **[SEQ]** - Specifies sequential playback mode for the current directory. Default is random mode.

Example:

001 [SEQ]: SEQ for sequential numerical order

By choosing [SEQ] you select sequential mode. Sorting is done in numerical order of file names (for naming details, see next chapter related to files organisation).

In the Sequential mode [SEQ], files which are not numbered are ignored.
Directories which do not comply to naming rules are ignored.

The default mode is the random mode RND. The files are not read again as long as all the files have not been read at least once. This information is not stored during a directory jump.

● **[Rxxx]** - Enables or disables one or several output contacts

A directory can activate different output contacts without any additional programming. You can switch on lamps, activate motors or any other action automatically when a directory is read.

Caution! Status of the outputs does not change whilst the file is read. To achieve this, you must use the Show Control function or cut the audio files in tracks.

001 [R001] - Enables output 1 while reading directory 001

001 [R255] - Enables all 8 outputs while reading directory 001

001 [R000] - Disables all outputs while reading directory 001

Values between 000 and 255 as per a binary progression. See the corresponding table in the annex.

The output contacts are commutated at the beginning of the directory playback. If files inside the directory carry an instruction to enable or disable the output contacts, the output status will evolve.

If an event file is read (Show Control function), the outputs can change with the scenario of the event file. We recommend to control the outputs in the Show Control editor.

● **[V+xx] or [V-xx] - Sets the volume level of the directory**

The name of the directory can include parameter to set the broadcast volume.

Example:

001 [V+05]: Increases volume by 5 steps

001 [V-03]: Decreases volume by 3 steps

After reading the directory, the volume goes back to the normal volume level set for the player.

- If variation values exceed the maximum or minimum level, levels are set at their maximum or minimum.
- If the volume is already at the maximum, the increase command is ignored
- If the volume is already at the minimum, the decrease command is ignored

● **[NT] or [DT] - This option defines the interruption mode of the current directory**

If these options are registered in the directory name, the file cannot be interrupted and commands received are ignored or executed at the end of the file.

Without this option, reading of the current file can be interrupted at any time by an external action. (input, Ethernet, RS232 ...)

Example:

001 [NT] - The directory is NOT interruptible.

In that case, an action on one of the input contacts, by programming, through Ethernet or RS232 link is ignored and the reading of the current file is not stopped. Caution! The action is not memorised and the triggering information is lost.

001 [DT] - Interruption instruction is memorised and will be executed at the end of the file.

In that case, an action on one of the input contacts, by programming, through Ethernet or RS232 link is memorised and the reading of the current file is not stopped. Caution! If several actions occur while reading the file, history of actions is not memorised and triggering information is lost. Only the last action is memorised and executed.

● **Specific behaviour :**

- If an action refers to a directory which is absent, the command is ignored.
- If an empty directory (no file) is called but the directory name includes an option, this option will be executed. If no option is indicated, the player goes to stop mode.

4.2 Organisation of files inside directories.

Like for directories, file names define their playback pattern.

Note: You may not have to use this notation if the files are read randomly ("RND" option or no option in the directory name). In this case, all the files shall be read and will be interruptible.

The file names are made up of 3 digits (000 to 999) and a name of your choice. Optional information can be added such as the file volume level or triggering of outputs.

Example:

001 [J367] my message.mp3

063 [R020] file name.wav

My file.sc2

845 [V+12][R001] my file.mp3"

xxx.wav -> Wave format audio file

xxx.mp3 -> MP3 format audio file

xxx.sc2 -> "Show Control" sequence file created using the ID-AL Show Control editor.

Note: In sequential mode (SEQ), if numbered and non-numbered files are present, only the numbered files will be read. In random mode, all the files be read.

In random mode, if the files are not numbered, they are interruptible.

● **The first three digits represent the file number file and thus its primary name.**

Example:

001.mp3 - file No.001

063.wav - file No.063

158.sc2 - file No.158

If the directory indicates random mode [RND], the files don't have to be numbered and playback will be in random mode. If the directory indicates definite sequence [SEQ], the non-numbered files are ignored.

Optional parameters

To modify the behaviour of the player, you can add optional parameters in the file name. These parameters are boxed by the "[" and "]" symbols. You can use several parameters in the file name.

[Jxxx] - Jump to a directory after reading the current file.

[NT] or [DT] - The file is not interruptible or the action is memorised to be executed at the end of the file.

[Rxxx] - Enables output contacts

[V+xx] ou [V-xx] - Sets the file volume level

Note: Without any option, the files are read one by one according to the selected mode (random or sequential) and can be interrupted at any time by external action.

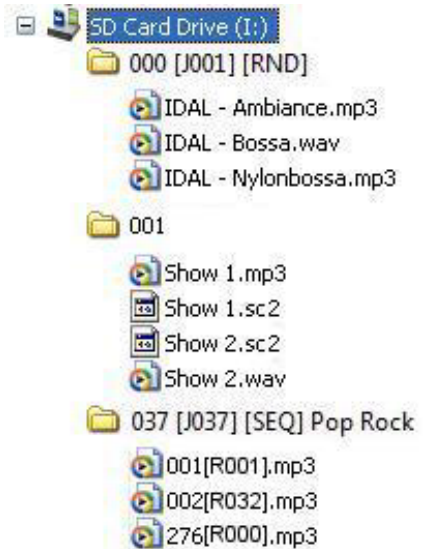

● **[Jxxx]** - Designates the directory No. to go to after the current file.

By adding this parameter to the file name after the file No., you define the behaviour of the player so that after reading the current file it goes to reading another directory.

If the destination directory does not exist or does not contain any file, the action is ignored.

Example:

xxx [J002].mp3 - Jumps to directory 002 after reading file xxx*

001 [J023].mp3 - Jumps to directory 023 after reading file 001

034 [J034].wav - Jumps to directory 034 after reading the file. It's not a loop with the file 034 but a jump to directory 034

*xxx refers to any number between 000 & 999

For example, this function helps to monitor a particular file so that it is followed by a skip action.

Several files can indicate the same skip directory.

Example:

001 [J100].mp3 - After reading file 001, jumps to directory 100

002 [J100].wav - After reading file 002, jumps to directory 100

999 [J100].sc2 - After reading file 999, jumps to directory 100

● **[NT] or [DT]** - This option defines the interruption mode of the current file

If these options are registered in the file name, the file cannot be interrupted and commands received are ignored or executed at the end of the file.

Without this option, reading of the current file can be interrupted at any time by an external action. (input, Ethernet, RS232 ...)

Example:

001 [NT].mp3 - The file is NOT interruptible.

In that case, an action on one of the input contacts, by programming, through Ethernet or RS232 link is ignored and the reading of the current file is not stopped. Caution! The action is not memorised and the triggering information is lost.

001 [DT].mp3 - Interruption instruction is memorised and will be executed at the end of the file.

In that case, an action on one of the input contacts, by programming, through Ethernet or RS232 link is memorised and the reading of the current file is not stopped. Caution! If several actions occur while reading the file, history of actions is not memorised and triggering information is lost. Only the last action is memorised and executed.

Interruptable and non-interruptable files can coexist in the same directory.

● **[V+xx] ou [V-xx] - Changing volume level of the file**

The file name can include an option to set a volume level when the file is read. This function is used to broadcast messages at a different volume than other files.

[V+05] - increases volume by 5 steps

[V-03] - decreases volume by 3 steps

After reading the file, the volume returns to the normal level of the player.

- If the values of variation exceed the maximum or minimum level, the levels are fixed at their maximum or minimum.

- If the volume is already set at the maximum, the increase command is ignored

- If the volume is already set at the minimum, the decrease command is ignored

Example:

my file [V+02].mp3 - Increases the volume by 2 steps

001 [V-12].wav - Decreases the volume by 12 steps

● **[Rxxx] - Enables or disables one or several output contacts**

Each file can activate different output contacts directly without any additional programming. You can switch on lamps, activate motors or any other action.

Caution! The status of the outputs cannot progress during the reading of the file. For that, you must use the Show Control function.

Example:

001 [R001].mp3 - Enables output 1 while reading file 001

001 [R255].wav - Enables the 8 outputs while reading file 001

my file [R000].mp3 - Disables all the outputs while reading "my file.mp3" file

The values are between 000 and 255 in binary progression. See the corresponding table in the annex.

The outputs are switched at the start of reading the file. If no other file has a switching option in its name, the outputs will not change and will not be disabled.

If an event file is read (Show Control function), the outputs can change according to the scenario of the event file. We recommend the use of Show Control function to control the output status.

5 - Menu & configuration

Several settings are accessible through the Data button to configure the EventPlayer.

The DATA button has 2 functions:

- 1 - Endless rotation in both directions
- 2 - Validation push button



DATA button

When the player is in normal mode (i.e. in a configuration menu), the rotation of the button allows adjustment of the volume level.

By pressing the button, you will be able to access the various set-up menus:

- 1 - Source selection (Player or Auxiliary)
- 2 - Bass & treble control of the player or the Auxiliary input
- 3 - Date & time setting
- 4 - Ethernet link parameters
- 5 - RS232 serial link parameters
- 6 - Miscellaneous options (Allocation of buttons, Fade in/out. Autoplay ...)
- 7 - Choice of display language

General usage of the button in the option menu:

- A rotation allows selection of a menu. Pressing confirms menu choice
- A rotation changes the value of the settings. Pressing confirms the selected setting and returns to the previous menu or moves to the next field.
- To exit the menu, turn the button until you see "Back" or "Exit" and confirm by pressing the button.

Reading the LCD display:

The menu name appears on the first line with below the associated parameter value.

To modify this value, press the button.

Volume control: Turn the DATA button to change the volume. It is also possible to configure the two buttons "1" and "2" to control volume. See "Option" menu.

Caution! The volume can also be changed through the serial link, Ethernet and file name.

To change the player broadcast volume, select the main source "MAIN" in the "SOURCE" menu.

To change the Auxiliary input broadcast volume, select the "AUX" source in the "SOURCE" menu.

First level menu choices:

SOURCE

PLAYER

Selects either the player or the auxiliary in source

Displays the selected source (Player or Aux)



TONE TRAIN

6:00M:00R:00

Controls the tone (in "AUX" mode, controls the tone of the AUX input)

Displays current values - G for Low / M for Medium / A for High



TIME

01/01/200800:00

Sets time and date of the player

Displays current date and time of the player



ETHERNET

192 . 168 . 1 . 1

Sets the parameters of the Ethernet link

Displays the default IP address value of the player



SERIAL RS232

001 / 9600 / DMSY

Sets the RS232 serial link parameters

Default value Player ID, link speed and operating mode



OPTIONS

Sets miscellaneous parameters such as allocation of buttons, fade in/out, autoplay, amplifier control...



LANGUAGE

FRANCAIS

Choice of display language

Default value



EXIT

Quits the option menu to go back to playback mode

Rotation = Menu choice

Click = Enter into the menu

SOURCE

Volume control of the Auxiliary input:

Select the source. A sound source can be connected to the auxiliary input of the player. To listen to it you must select the "AUX" mode. To listen to the player, select "MAIN" mode

MAIN Player mode
AUX Auxiliary Mode

TOUR MAIN

Tone control of the player:

TOUR AUX

Tone control of the Auxiliary input:

You can independently control the tones of the player and the auxiliary source. You access the tone controls depending on the selected source "Main" or "Aux"

BASSE : 00 DB



MEDIUM : 00 DB



TREBLE : 00 DB



EXIT

The default values are set to 00dB, without tone correction.
Select the parameter to be adjusted, turn the button and confirm.

TIME

Date & time setting:

You must set these parameters for scheduled programs.

DATE : DD/MM/YYYY Press button and turn. Each pression goes to next field
01 / 01 / 2008



TIME : HH:MM
00:00

Press button and turn. Each pression goes to next field



HEURE ETE/HIVERS
ON

To automatically switch between summer/winter times



EXIT

ETHERNET

Setting the Ethernet link parameters:

To operate, the Ethernet link must be configured. The player uses an IP address for being recognised on the network, a network mask and a gateway to communicate through a router.

IP ADDRESS 192.168.1.1	Press button and turn. Each pression moves to next field
↓	
NET MASK 255.255.255.0	Press button and turn. Each pression moves to next field
↓	
GATEWAY 192.168.1.255	Press button and turn. Each pression moves to next field
↓	
EXIT	

SERIE RS232 **Setting of the RS232 serial link parameters:**

To operate, the serial link must be configured. The player uses a transmission speed and an operating mode. See the chapter related to serial link to obtain operational details.

PLAYER ID 001	In Daisy Chain mode, the player must have a specific address.
↓	
BRUDRATE 9600	Press button and turn to select transmission speed.
↓	
MODE DAISY	Press button and turn to select mode. "Daisy" or "Ctrl" Mode. See chapter related to RS232 link for details.
↓	
EXIT	

OPTIONS **Setting the player options:**

Several options are available to customise the EventPlayer.

AMPLIFIER ON	The internal amplifier can be disabled. Choose On or OFF
↓	
AUTOPLAY 0 0 0	Parameter used to set the behaviour of the player on powering on. Either the player is set in sleep mode (OFF) or it reads a selected directory from 000 to 999 or it switches to the auxiliary input (AUX).
↓	
PASSWORD OFF	The password denies access to the DATA button. You may either set this parameter on OFF or select a value of 4 digits from 0000 to 9999 that you will have to key-in using the DATA button in the Option menu.
↓	
BUTTON 1 STOP	Buttons 1 & 2 may be assigned to functions of your choice. See various choices given below.
↓	
BUTTON 2 EXIT MENU	Buttons 1 & 2 may be assigned to functions of your choice. See various choices given below.

↓
FADE IN AUX
SECOND(S)

When switching to the auxiliary input, sound level goes from its minimum to its maximum in a set time.

↓
FADE OUT AUX
SECOND(S)

When switching back to the player, sound level goes from its maximum to its minimum level in a set time.

↓
EXIT

Allocation parameters for buttons 1 & 2:

NONE: no effect.

STOP / PAUSE / PLAY: Stops reading, momentarily stops reading or reads current directory.

PLAY DIRECTORY xxx: Starts reading directory xxx.

NEXT or PREVIOUS: Reads next or previous track.

AUX: Switches input: Auxiliary (one more press goes back to the player).

EXIT MENU: Exit the Option menu

LANGUAGE

Language display setting:

You can choose to display the language of your choice on the LCD. Enter the menu and select the desired language.

5.1 - Password of the player

It is possible to prevent access to the configuration menu by blocking the "Data" button with a password.

- Enter the configuration menu and select "Option" menu. Select "Password" and choose a 4 digits password. Then exit the menu.

- If you press the DATA button or if you turn it, the display will request a password. To enter the password, press the button and turn it to select the first digit. Once again press the button to select the second digit and so on to the fourth digit. If the password is correct, you can access the configuration menu.

Note: When using a password, volume level control with "DATA" button is also blocked. If you wish to access the volume from the front panel, it is possible to assign this function to the two buttons 1 & 2.

6 - USB Link (device)

The EventPlayer reads files stored on a SD memory, a USB stick or a USB hard disk.

To update a USB stick or a USB hard disk, you just have to connect these elements directly to a computer. A card reader is required to update a SD card.

If you do not have an external card reader or one on your computer, you can use the front USB port to access the card.

To set-up the player in USB mode, switch the EventPlayer on and connect the USB cable. The computer will then detect this new peripheral and display it in your file manager using the "Mass Storage" standard driver.

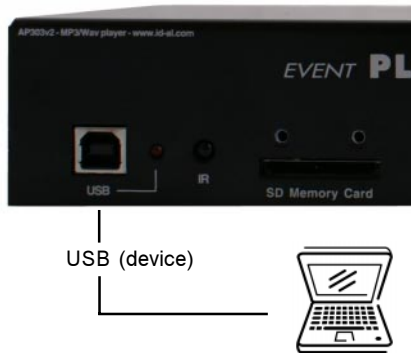

7 - HOST USB Link

The HOST USB port allows data media connection (USB stick, hard disk).

Mass media (stick or HDD)

Data media with USB flash drive or external hard disk is an alternative to SD memory card. Simply connect the memory stick or a hard disk on this USB port with the same file organisation. This memory must be formatted in FAT or FAT32 (see chapter related to organisation of directories and files).

If you connect a stick or a hard disk, you must remove the SD card from the player. If a SD card is present, it will be given priority and the stick or the hard disk will be ignored.



When inserting or removing a SD card or a USB stick, the player must be switched off.

8 - DMX Link

The EventPlayer is not just an audio player, it can also read sequence files in order to operate DMX512 devices.

Using the Show Control Sequencer (free download from www.id-al.com) you will be able to create complete scenarii managing both broadcast of sound and sending commands to devices connected on the DMX port, in perfect synchronisation.

You are invited to refer to the software manual to use this function.

To this output you can connect any device compatible with the DMX512 protocol, such as dimmers, gen-lock projectors, DMX converters towards relays or servomotors.



DMX Output

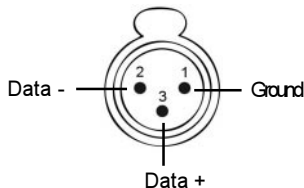

9 - Auxiliary Input

By inserting the EventPlayer in an audio system, between audio source (computer, satellite receiver, multi CD player, tuner ...) and the amplification system, you will be able to trigger messages according to scheduled programming, action on input contacts or remotely via the internet.

The player acts as a message box to broadcast local information or adverts.

Switching of the auxiliary input is managed through the directory name (see related chapter). When a command is received to cut-off the auxiliary input in order to broadcast a message, the Auxiliary sound input fades out, down volume level 0. After broadcast of messages, a command to switch back to the auxiliary source is sent and volume level of the external source fades in from 0 to the maximum level. The Fade in/out time is adjustable in the Option menu.

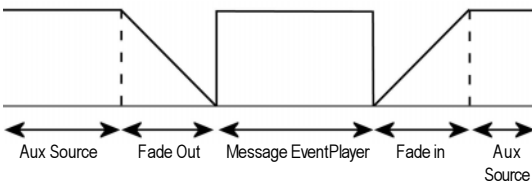

Aux input

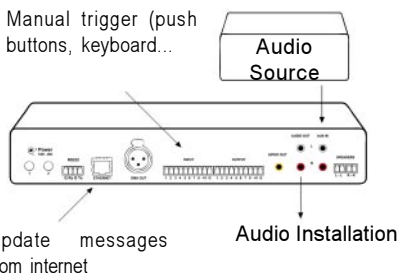

10 - Input and output contacts

The EventPlayer is interactive. It has trigger input and output contacts to action various electrical devices.



8 Input

8 Output

10.1 - Input contacts

By connecting contacts to inputs, it is possible to start reading directories. You can change the style of music, start a sound & light show, trigger messages ...

Example of connections:

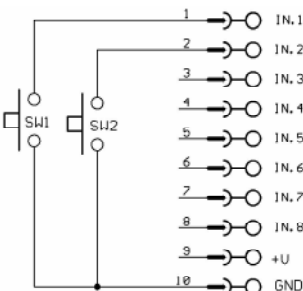

Example with push buttons to start directory 1 & 2

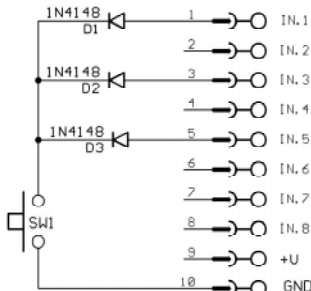

Example of input combination to start directory 21

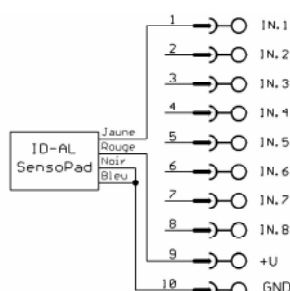

Example of external trigger using power supply of the player

The inputs are opto-couplers actioned by a contact between the input and the ground. Onto the inputs, you can connect different types of contacts: push button, relay, presence detector, output of a remote receiver, light or heat sensor, IDAL SensoPad.

By combining inputs, you can obtain up to 255 triggers. You can use diodes, relays or a multiplexer to create binary combinations (see annex for the connections).

The activated input(s) will trigger the associated directory No.

- Input 1: Directory 001
- Input 2: Directory 002
- Input 3: Directory 004
- Input 4: Directory 008
- Input 5: Directory 016
- Input 6: Directory 032
- Input 7: Directory 064
- Input 8: Directory 128

Note : V+ is voltage output from the main power supply. With a 12V power supply, V+ will be 12V out. Max output is 300mA.

Example of combinations required to trigger the following directories:

- Directory 003: make a contact between inputs 1, 3 & GND
- Directory 007: make a contact between inputs 1, 2, 3 & GND
- Directory 082: make a contact between inputs 2, 5, 7 & GND
- Directory 234: make a contact between inputs 2, 4, 6, 7, 8 & GND

10.2 - Output contacts

The EventPlayer can enable output contacts to operate various devices. You can switch on lamps, relays, motors ... The output contacts are activated through directory or file names, remotely via the Ethernet or RS232 link or by scheduled programming (see related chapters).

The output contacts of the EventPlayer are opto-couplers (see diagram below). The power output is limited (switching up to 60V/50mA max) and only low power devices can be controlled, LED or small relays. To switch high power devices you must use an interface between the outputs and the device to be controlled such as the ID-AL MicroSwitch.

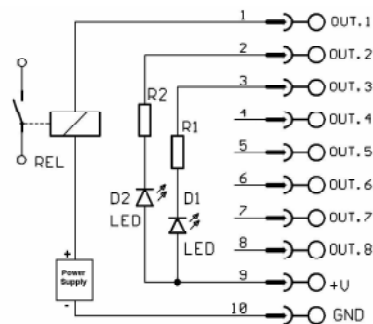
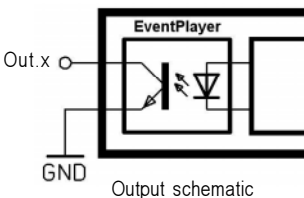

Example of output to control LEDs and a relay with an external power supply.

Note : V+ is voltage output from the main power supply. With a 12V power supply, V+ will be 12V out. Max output is 300mA.

11 - Ethernet link

Via the Ethernet link, the EventPlayer communicates to update content via FTP (SD card, stick or USB HDD) and to receive commands in html Web server and check status of the player or outputs.

You can use the player in a local network. An adequately configured Modem/Router will allow remote control of the player via the Internet.

Caution! Network administration requires good computer skills.



Ethernet link

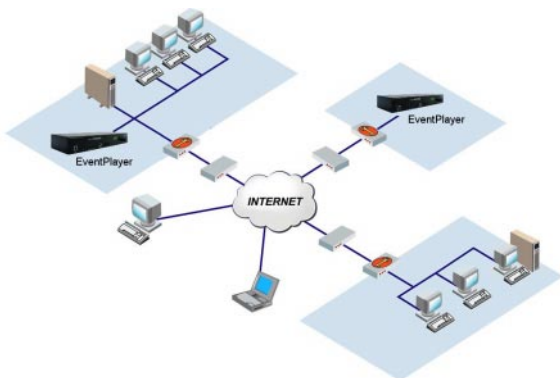

In a local network installation, the player requires an IP address. This address is set in the Option menu (see option menu chapter). The player is then recognised on the network as a Web Server with "Internet Explorer" or "Firefox" browsers and as a FTP server with a FTP software such as Filezilla.

In an installation where only the player is present or in a local network with external access, you must use a Modem/Router to create a gateway between the player and the Internet. Since the Modem/Router is configured with an IP gateway, you must declare this gateway to the EventPlayer so that it can communicate (configured in the Option menu).

Note: The EventPlayer does not offer DHCP mode.

11.1 - Connection of EventPlayer to the Internet through an ADSL link, without local network nor computer

Hardware required:

EventPlayer + ADSL Modem / Router

Connect your player to your ADSL Modem/Router with a RJ45 cable and connect your Modem to a telephone jack with ADSL filter.

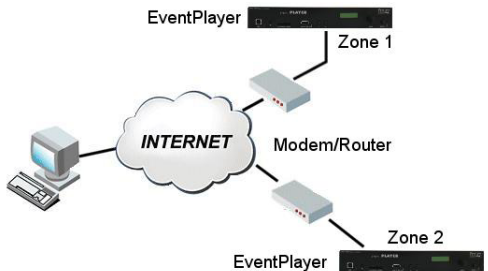

A - You have an IP address provided by your service provider

Configure your Modem/Router entering the player IP address, access data to provider (account, password ...), Gateway used and the various configurations related to your Modem. Also set the IP and Gateway of your player. Open the FTP communication ports (21) and the HTTP ports (80) in the Modem.

On a computer connected to the Internet and a browser, type the IP address of your connection. The window of your player should be displayed.

B - You don't have a permanent IP address

This is a solution to make your player visible over the internet without using a permanent IP address. We suggest you to use a service provider offering "DynDNS" service. It's a dynamic DNS service modifiable with every change in the IP of your service provider. For example, you can use the free service on www.dyndns.org.

At first, you must open an account with a service provider and obtain your Host name, User name and password. Caution! Your Modem / Router must have this feature.

Configure your Router Modem accordingly and validate the DynDNS option.

The principle is as follows:

When the IP address changes, the Modem sends this information to the DynDNS server. The service immediately carries out the modification in its database to point out the new address on the host name.

Therefore, the player remains visible over the Internet even in case of change in the IP address of the service provider or in case of a cut-off.

11.2 - Linking a player to an internal network

Hardware required:

- EventPlayer
- Ethernet Hub
- One or several computers can be present

Connect the player to the network hub. The player is comparable to a computer. It has its own IP address and will be seen over the network like a machine. It will be able to communicate with various network stations. If the network itself is connected to the outside, then the player will be seen from external machines.

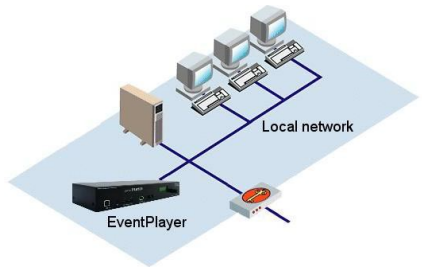

11.3 - HTML Web server

Open your Web browser on your computer (for example Internet Explorer) and enter the IP address of the player (the IP address is configured in the Option menu of the player). The home page should be displayed and you should be requested to enter your account and password.



The screenshot shows a web interface with a purple header titled 'Identification'. On the left is the IDAL logo and a padlock icon. On the right is a form with 'User:' and 'Password:' labels, each followed by a text input field. Below the fields is a 'Validate' button.

© 2008 - Copyright Waves System - ID-AL - All rights reserved

Default value:

Account (user): idalweb

Password: idalweb

You will be able to modify account name and password in the configuration page.

Enter the requested information and validate to get access to the main page.

Control Config About us Sign out

Control panel

STATUS :

Play Stop FTP Error Error message

Directory : _____ - Time _____ : _____

File : _____

Change Directory : _____ **Validate**

OUTPUT :

Status Output :

1 2 3 4 5 6 7 8

Change Output :

1 2 3 4 5 6 7 8 **Validate**

VOLUME :

Volume Player :

_____ 01 ▾

Volume Aux. :

_____ 01 ▾ **Validate**

© 2008 - Copyright Waves System - ID-AL - All rights reserved

The page is composed of 3 parts:

A - Status of the player

This block displays the status of the player as well as the directory name and name of the file being read. You can change the current directory by entering the desired number and click on "Validate".

B - Status and operation of the output contacts

The first line indicates the current status of the output contacts while the second line allows status modification. Simply click on the output number(s) that you wish to enable and click on "Validate".

C - Volume level control

The fields on the left indicate the current volume level of the player. To modify, select a value from the field on the right and click "Validate" to send the information to the player.

To change page, click on one the selected tab at the top of the page. (Control, Config, About us, Sign out)



Control	Config	About us	Sign out
-------------------------	------------------------	--------------------------	--------------------------

Configuration

DATE / TIME :

Date :	<input type="text" value="01"/>	/	<input type="text" value="january"/>	/	<input type="text" value="2008"/>
	<input type="text"/>	/	<input type="text"/>	/	<input type="text"/>
Time :	<input type="text"/>	:	<input type="text"/>		
	<input type="text"/>	:	<input type="text"/>		

[Validate](#)

FTP ACCESS :

User :	<input type="text"/>
Password :	<input type="text"/>

[Validate](#)

WEB ACCESS :

User :	<input type="text"/>
Password :	<input type="text"/>

[Validate](#)

FIRMWARE VERSION :

<input type="text"/>

The "config" menu allows setting of parameters of the player. You can modify the date and time as well as the various user accounts and passwords for Ethernet access.

Enter the information you wish to modify and click on "Validate".

If you have lost the account names and passwords, you must make a "Reset Factory" to initialise the player and revert to factory settings.

The "WEB access" parameters define the access modes to the html interface which is the one you see when you use a browser.

The "FTP access" parameters define the access modes to the FTP interface which you will use to update content of the memory cards or USB sticks. (See chapter below)

The last page "About us" displays ID-AL contacts.

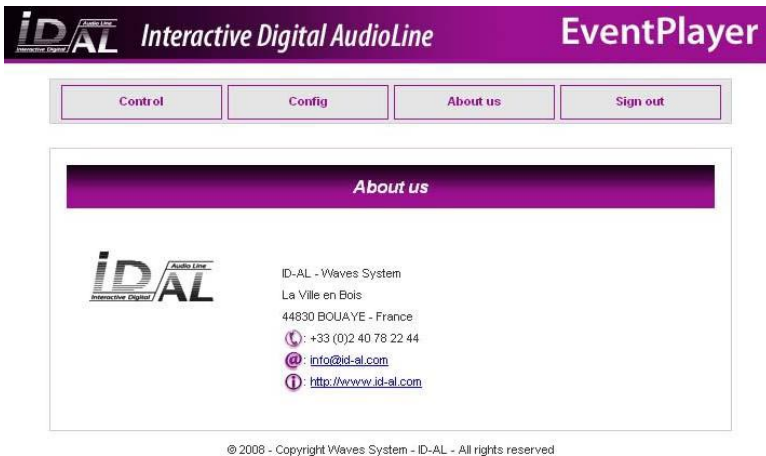

Click on "Sign out" to log out.

11.4 - Use in FTP client

This facility is used to update content of the storage devices, SD card, USB stick or USB hard disk. Connect the EventPlayer using a "FTP client" software.

Demonstration purposes, we are using the freeware "FileZilla" but any other software may also be appropriate.

- Run "FileZilla"
- Enter the IP No. or the FTP address of the player
- Enter user name and password you have configured during installation

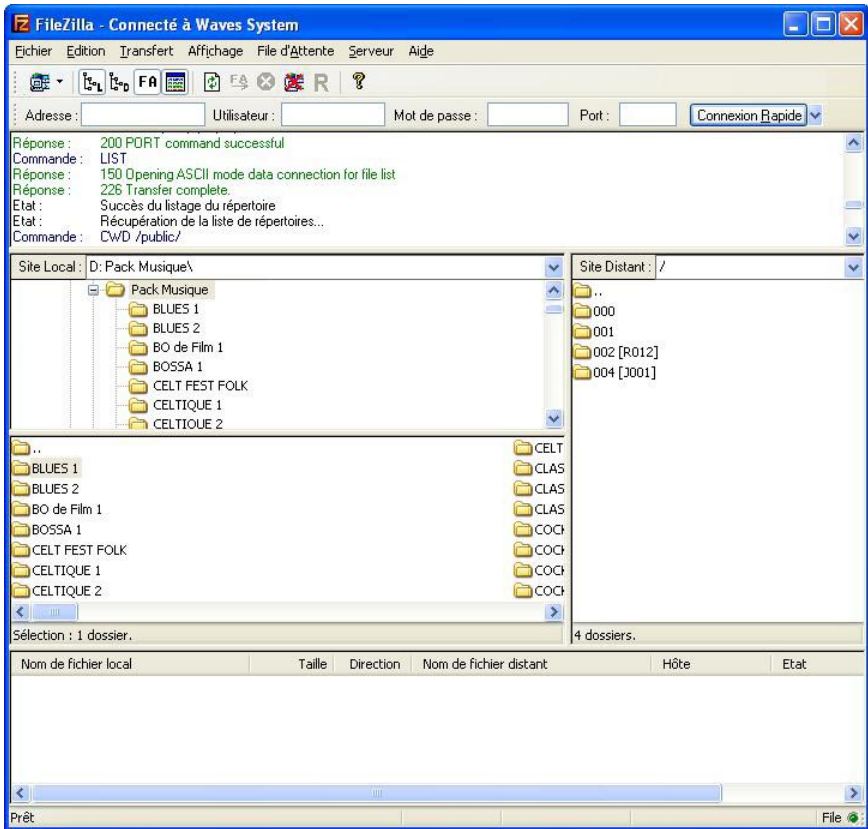

By default the user name is: idalftp
The password is: idalftp
Port: 21

You are now connected to the media of the player and you have access to copy, delete, move, edit of file names as you would do locally.

Please refer the user manual of your FTP software for further user details.

Precautions for use:

- 1 - Prohibit multiple simultaneous transfers.
- 2 - Avoid using the passive mode. (if the function is available)

12 - RS232 serial link protocol

The EventPlayer can communicate with other devices. It receives commands on the Rx input and sends data through the Tx output. The player complies with the RS232 norm (see specification).

12.1 - Reception Protocole - «Daisy chain» Mode

The EventPlayer can receive commands to start reading a file. If the same link is used to control several players, each player will only execute commands addressed to its own number, allocated in the Option menu.

The reception protocole is made of a 3 bytes frame.

Byte 1 (status) + Byte 2 (command) + Byte 3 (data)

Reminder:

- a byte is composed of 8 bits: b7 b6 b5 b3 b2 b1 b0
- a binary representation is noted: xxxxxxxb or in hexadecimal : xxh

Byte 1 : Status - 1xxxxxxb

- > b7 = 1: refer to a status byte
- > b6 - b0: player identification to be addressed to from 001 to 127 (000001b - 1111111b)

- The default player address (ID) is 001. You can change it in the Option menu.
- Several players may have the same identification number to create groups.
- Identification 000 is the "global" code, all players are concerned by the command (unique command for all the players, see " Daisy Chain " function).

Byte 2 (Command) + Byte 3 (Data) - 0xxxxxxb

- Byte 2: command (command byte is always followed by a byte of data).

- > b7 = 0 : refer to a byte of command or data
- > b6, b5, b4 : bank selection for the «go to directory» command
- > b3, b2, b1, b0 : command code sent to the player

List of commands:

● **00000000b: not used**

● **0xxx0001b : Go to a directory**

The directory is referred to by the range number and the byte of data which follows.

xxx is the range number. To address 1000 directories (from 000 to 999), it is necessary to divide this number in several ranges of 128 values.

xxx: Range number depending on the directory number
000b: Range 0 -> from 000 to 127
001b: Range 1 -> from 128 to 255
010b: Range 2 -> from 256 to 383
011b: Range 3 -> from 384 to 511
100b: Range 4 -> from 512 to 639
101b: Range 5 -> from 640 to 767
110b: Range 6 -> from 768 to 895
111b: Range 7 -> from 896 to 999 (binary values over 999 are ignored).

Method of calculation:

- 1) range = value from the above table in relation to the directory number
- 2) value = directory number - range x 128

Example of a frame triggering directory 278 in player number 6:

Directory number = 278

- 1) 278 is in range 2 (from 256 to 383) - table above
- 2) Value = 278 - 2 x 128 = 22

The frame is:

Byte 1: 10000110b (86h) : status byte, player number 6
Byte 2 : 00100001b (21h) : range 2, go to command (0001b)
Byte 3 : 00010110b (16h) : value 22

● **00000010b : Transport bar command**

The function is defined by the byte of data as follows:

Value of data for byte 3:

00000001b (01h) : Play
00000010b (02h) : Stop
00000011b (03h) : Next file in the current directory
00000100b (04h) : Previous file in the current directory

Note: the other values are ignored.

● **00000011b : setting of volume**

Value is defined by the following data byte:

Values of data for byte 3 included between 0 and 64

00000000b (00h) : Mute (0)
00100000b (20h) : Volume maximum (64)

Note : Any other value will be ignored

12.2 - Transmission Control Protocol

The EventPlayer provides 2 data transmission modes:

- 1 - One mode of information transfer, information which comes in, goes out identically (Daisy Chain)
- 2 - One mode - surveillance mode - sending information on changes of status

The modes are defined in the configuration file (see related chapter)

Note : The different transmission modes are not compatible with the Show Control mode sending serial command included in the sequence file. If a sequence file is read, the serial link is deactivated. To prevent any conflict, we suggest to desactivated the transmission mode in the menu option.

Mode 1 : "Daisy Chain" (default mode)

In this mode, any information received on the Rx line is sent out as received on the line Tx. Several EventPlayers can be linked by connecting the Tx output of the first one onto the Rx input of the next one and so on... Data received by the first player on Rx are sent out on Tx and received on the Rx input of the next player in the chain. Note: if a large number of players are connected this way, a slight delay may occur at the end of the chain.

Mode 2 : "Surveillance"

In these Surveillance modes, the player is sending status report information onto its Tx output; for each change of status, the player is sending the related information onto the Tx output. It is not possible to link up several players. The data can then be processed and analysed by a controller, computer, security device.

The transmission protocol, as the reception protocol, is made of a 3 byte frame.

Byte 1 : Statut

> b7 = 1 : indicates the status byte

> b6 - b0 : identification of the sending player from 001 to 127 (000001b - 1111111b)

The default address (ID) is 001. Setup in the Option menu.

Byte 2 (Command)

Unique value: 00000000b (00h).

The command code is 0000b, the other bits are reserved and have the 0 value.

Byte 3 (Data)

00000000b (00h) : Player ready - The player reports that it is ready and available - On powering on, after USB mode, insert of a memory card...

00000001b (01h) : Not used

00000010b (02h) : Not used

00000011b (03h) : Indicates start of playing - This code is sent when the player starts playing.

00000100b (04h) : Indicates end of playing - The player points out that it has finished reading the current file.

00000101b (05h) : Connecton in FTP mode. The player indicate the FTP Mode and is therefore not available for playing a file.

00000110b (06h) : Not used

00000111 (07h) : Switching to USB mode. The player indicates that it goes into USB mode and is therefore not available for playing a file.

Example of a cycle created to check the correct operation of the player by playing a file.

Preparation : The player's number is 001

Create a directory «100 My directory» and copy into it a file «My file.mp3»

Structure of the frame to be sent to the player:

10000001 (81h) - 00000001 (01h) - 01100100 (64h)

Player number 001 + Range 0 / go to command + Directory number 100

On receipt, the player sends a frame indicating start of playing:

Start playing:

10000001 (81h) + 00000000 (00h) + 00000011 (03h)

At the end of file, the player sends a frame indicating end of playing:

10000001 (81h) + 00000000 (00h) + 00000100 (04h)

13 - Reset factory

In some situations such as mistake, forgotten password, new installation, you may need to reinstall EventPlayer with the original settings. In this case, all configurations will be erased and you will have to set again the parameters of the Option menu as if for a new device.

To carry out a reset factory and erase all the settings in order to restore them to the default values:

- 1 - The player must be switched-off
- 2 - Press the button "2" on the front panel and keep it pressed
- 3 - Switch on the player
- 4 - As soon as the message "factory reset" appears on the screen, release the button and wait
- 5 - When the reset process is completed, the usual welcome message is displayed
- 6 - Enter the Option menu to configure the elements you wish, like time and date.

Annex B - Specifications

- **Power supply :**

Nominal Voltage : 12V DC

Supply Range : 10V to 15V DC

- **12V supply consumption:**

- Playing (output on line level - amplified output not used) : < 200 mA

- Playing - amplifier to its maximum under 8 Ohms: 3A

- **Audio output:**

Voltage 12V - THD 10% - Charge 8 Ohms : 2 x 10W

Voltage 12V - THD 0,5% - Charge 8 Ohms : 2 x 7,5W

Voltage 14,4V - THD 10% - Charge 4 Ohms : 2 x 20W

Voltage 14,4V - THD 0,5% - Charge 4 Ohms : 2 x 15W

- **Size:**

Width: 287mm (1/3 rack) - Height: 43mm

Depth without connectors: 105mm - Depth with connectors: 135mm

Weight : 800g

Volume table

0	MUTE	22	-42dB	44	-20dB
1	-63dB	23	-41dB	45	-19dB
2	-62dB	24	-40dB	46	-18dB
3	-61dB	25	-39dB	47	-17dB
4	-60dB	26	-38dB	48	-16dB
5	-59dB	27	-37dB	49	-15dB
6	-58dB	28	-36dB	50	-14dB
7	-57dB	29	-35dB	51	-13dB
8	-56dB	30	-34dB	52	-12dB
9	-55dB	31	-33dB	53	-11dB
10	-54dB	32	-32dB	54	-10dB
11	-53dB	33	-31dB	55	-9dB
12	-52dB	34	-30dB	56	-8dB
13	-51dB	35	-29dB	57	-7dB
14	-50dB	36	-28dB	58	-6dB
15	-49dB	37	-27dB	59	-5dB
16	-48dB	38	-26dB	60	-4dB
17	-47dB	39	-25dB	61	-3dB
18	-46dB	40	-24dB	62	-2dB
19	-45dB	41	-23dB	63	-1dB
20	-44dB	42	-22dB	64	0dB
21	-43dB	43	-21dB		

Annex C - Functions

Audio characteristics

- Reads MP3 files mono/stereo (MPEG ½ layer 3), 44.1KHz / 48KHz, from 64kbit/s to 320kbits/s
- Reads CBR (Constant Bit Rate) and VBR (Variable Bit Rate) files
- Reads WAV files mono/stereo 16 bits : 44.1kHz/48kHz/88,2kHz/96kHz - 32bits : 44.1kHz/48kHz
- Volume setting in 64 steps from 00 to 64
- Setting of bass, medium and treble from -14dB to +14dB in 2dB steps
- Analog audio stereo output on RCA connectors
- Digital (S/PDIF) audio stereo output on RCA connectors
- Audio amplified on terminal block

Mass storage

- Accept Flash SD cards formatted in FAT16 and FAT32
- Accept Flash USB sticks formatted in FAT16 and FAT32
- Accept external USB Hard Disk formatted in FAT16 and FAT32
- Handle long file names (63 characters max including extension)
- Handle 1000 directories at the root, containing 1000 files maximum each

Interfacing

- 2 configurable buttons in front of the player
- Data encoder with push button in front of the player
- LED status indicator (USB device, USB Host, Power supply)
- Infrared sensor- Play, Stop, Next, Previous, call directories, Volume +, Volume -
- Frame of 12 bits modulated at 38kHz
- USB 2.0 Full Speed (12Mb/s), standard pilot «mass storage», connector type A
- USB HOST 2.0 Full Speed (12Mb/s), standard pilot «mass storage», connector type B
- Serial link RS232 - 19200 bauds, 8, N, 1, no flux control
- 8 digital inputs opto-coupled on connector Phoenix 3.81mm
- 8 digital output opto-coupled on connector Phoenix 3.81mm
- Power supply connector for carrying forward
- DMX output on connector female XLR 3 points
- Ethernet link on connector RJ45 - 10/100
- Auxiliary analog stereo input on RCA connector

Encryption

- Compatible with the encryption tool v1 or v2. On demand.

Annex D - Infrared remote control

An infrared sensor is fitted in the front of the EventPlayer to control the main functions.



With this remote control you can :

Transport command : Play / Stop / Next / Previous

Volume command : Change volume up/down

Trigger key : Same function than buttons 1 and 2 in front of the player. (configurable button)



<http://www.id-al.com>

<http://www.wsystem.com>