

## Presentation Switcher

# MSD-402

<User's Guide>

Ver.1.0.0

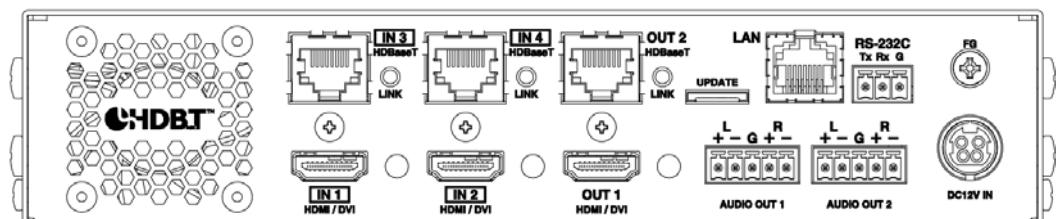
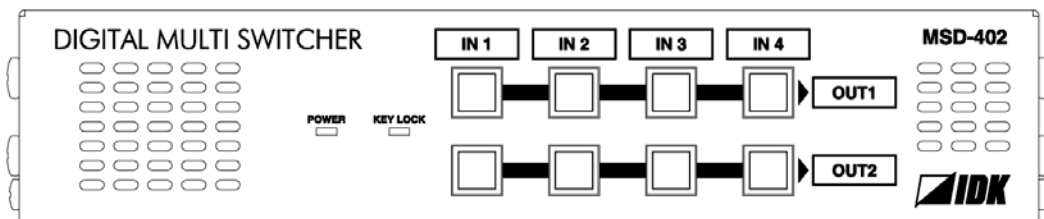

- Thank you for choosing our Digital Multi Switcher.
- To ensure the best performance of this product, please read this User's Guide fully and carefully before using it and keep this manual beside the product.

## Trademarks

- Blu-ray Disc and Blu-ray are trademarks of Blu-ray Disc Association.
- The terms HDMI and HDMI High-Definition Multimedia Interface, and the HDMI Logo are trademarks or registered trademarks of HDMI Licensing, LLC in the United States and other countries.
- PJLink is a trademark in Japan, the United States, and other countries/regions.
- HDBaseT™ and the HDBaseT Alliance Logo are trademarks of the HDBaseT Alliance.
- Microsoft, Windows, Internet Explorer are either registered trademarks or trademarks of the Microsoft Corporation in the United States and other countries.
- ETHERNET is registered trademark of Fuji Xerox Corporation.
- Mozilla, Firefox and its logo are trademarks or registered trademarks of the Mozilla Foundation in the United States and other countries.
- Google Chrome is trademark or registered trademark of Google Inc.
- Javascript® is trademark or registered trademark of the Oracle Corporation and its related companies in the United States and other countries.
- Oracle and Java are registered trademarks of the Oracle Corporation and its related companies in the United States and other countries.
- All other company and product names mentioned in this manual are either registered trademarks or trademarks of their respective owners. In this manual, the "®" or "™" marks may not be specified.

# Before reading this manual

- All rights reserved.
- Some of the contents in this user's guide such as appearance diagrams, menu operations, communication commands, and so on may differ from the MSD depending on the version.
- This Users guide is subject to change without notice. You can download the latest version from IDK's website at: <http://www.idk.co.jp/en/index.html>

The reference manual for the MSD consists of the following two volumes:

- User's guide (this document):  
Provides explanations and procedures for operations, installation, connections among devices, I/O adjustment and settings.
- Command guide: Please download the command guide from the website above.  
Provides explanations and procedures for external control using RS-232C and LAN communications.

## FCC STATEMENT

This equipment has been tested and found to comply with the limits for a Class A digital device, pursuant to part 15 of the FCC Rules. These limits are designed to provide reasonable protection against harmful interference when the equipment is operated in a commercial environment. This equipment generates, uses, and can radiate radio frequency energy and, if not installed and used in accordance with the instruction manual, may cause harmful interference to radio communications. Operation of this equipment in a residential area is likely to cause harmful interference, in which case the user will be required to correct the interference at their own expense.

## CE MARKING

This equipment complies with the essential requirements of the relevant European health, safety and environmental protection legislation.

## WEEE MARKING











Waste Electrical and Electronic Equipment (WEEE), Directive 2002/96/EC  
(This directive is only valid in the EU.)







This equipment complies with the WEEE Directive (2002/96/EC) marking requirement.  
The left marking indicates that you must not discard this electrical/electronic equipment in domestic household waste.





# Safety instructions

Read and understand all safety and operating instructions before using this product. Follow all instructions and cautions as detailed in this document.

Enforcement Symbol	Description
 <b>Warning</b>	Indicates the presence of a hazard that may result in death or serious personal injury if the warning is ignored or the equipment is handled incorrectly.
 <b>Caution</b>	Indicates the presence of a hazard that may cause minor personal injury or property damage if the caution is ignored or the equipment is handled incorrectly.

Symbol	Description	Example
 Caution	This symbol is indicated to alert the user. (Warning and caution)	 Electrical Hazard
 Prohibition	This symbol is intended to prohibit the user from actions.	 Do not disassemble
 Instruction	This symbol is intended to instruct the user.	 Unplug

 <b>Warning</b>	
 <b>Prohibition</b>	<b>Do not place the product in any unstable place.</b> Install the product to a horizontal and stable place. Otherwise, it may fall/turn over and lead to injury.
	<b>Do not place the product in any environment with vibration.</b> Otherwise, it may move/fall and lead to injury.
	<b>Keep out any foreign objects.</b> In order to avoid fire or electric shock, do not allow foreign objects, such as metal and paper, to enter the product from the vent holes.
	<b>For power cable/ plug:</b> <ul style="list-style-type: none"> <li>• Do not scratch, heat, or modify, including extending them.</li> <li>• Do not pull, put heavy stuff on them, or pinch them.</li> <li>• Do not bend, twist, or tie them together forcefully.</li> </ul> If they are used in those states continuously, it may cause fire or electric shock. If power cables/plugs become damaged, contact IDK.
 <b>Do not disassemble</b>	<b>Do not repair, modify or disassemble.</b> Since the product includes high-voltage part, those actions may cause fire or electric shock. For internal inspections or repairs, contact IDK.
 <b>Do not touch</b>	<b>In the event of lighting or thunder, do not touch the main unit and cables such as power cable and LAN cable.</b> Contact may cause electric shock
 <b>Instruction</b>	<b>For installation:</b> The product is intended to be installed by skilled technicians. For installation, please contact a system integrator or IDK. Otherwise, it may cause fire, electric shock, injury, or property damage.
	<b>Set the power plug in a convenient place to unplug easily.</b> You can easily unplug in case of any extraordinary failure or abnormal situation, and it also helps for unplugging when you do not use it for a long period.
	<b>Plug the power plug into appropriate outlet completely.</b> If the plug is plugged incompletely, it may overheat which causes electrical shock or fire. Do not use damaged plug or loosened outlet.
	<b>Clean the power plug regularly.</b> If the plug is covered in dust, it may cause fire due to reduced insulating power.
 <b>Unplug</b>	<b>Unplug immediately if the product smokes, makes unusual noise, or smells.</b> If you continue to use the product under those situations, it may cause electric shock or fire. After confirming that the product stops smoking, contact IDK.
	<b>Unplug immediately if you drop the product or if the cabinet is damaged.</b> If you continue to use the product under those situations, it may cause electrical shock or fire. For maintenance and repair, contact IDK.
	<b>Unplug immediately if water or other objects are directed inside.</b> If you continue to use it under those situations, it may cause electrical shock or fire. For maintenance and repair, contact IDK.
<b>For connection</b>	
 <b>Instruction</b>	Differences in ground potential among the product and peripheral devices may cause electric shock or damage of the devices. When using cables to connect devices, including connection of long-distance transmission, unplug the power cables of all related devices. After connecting signal/control cables of each device, plug in the power cables of each device.

 <b>Caution</b>	
 <b>Prohibition</b>	<p><b>Do not place the product in any place where it will be subjected to high temperatures.</b> If the product is subjected to direct sunlight or high temperatures, it may cause fire.</p>
	<p><b>Do not place the product in humid, oil smoke, or dusty place.</b> If the product is placed near humidifiers or dusty area, it may cause fire or electric shock.</p>
	<p><b>Do not block the vent holes.</b> If ventilation slots are blocked, it may cause fire or failure due to internal heat.</p>
	<p><b>Do not put heavy items on the product.</b> It may fall/turn over and lead to injury.</p>
	<p><b>Do not exceed ratings of outlet and wiring devices.</b> If several plugs are put in an outlet, it may cause fire and electric shock.</p>
	<p><b>Use only the provided AC adapter and power cable.</b> If non-compliant adapter or power cables is used, it may cause fire or electrical shock. Use the provided AC power connection cable. If you want to use your product in other countries that use different AC power cables, contact IDK.</p>
 <b>No wet hands</b>	<p><b>Do not plug or unplug with wet hands.</b> It may cause electrical shock.</p>
 <b>Instruction</b>	<p><b>Use and store the product within the specified temperature/humidity range.</b> If the product is used outside the range continuously, it may cause fire or electric shock.</p>
	<p><b>Turn off devices when they are connected to another device.</b> It may cause fire or electric shock.</p>
 <b>Unplug</b>	<p><b>Unplug the power plug if you do not use the product for a long period.</b> In case of defect, it may cause fire.</p>
	<p><b>Unplug the power plug before cleaning.</b> It may cause electric shock.</p>

**For installation**

**For rack mount devices:**

 <b>Instruction</b>	<p>Mount the product to the rack meeting EIA standards, and maintain spaces above and below for air cooling. For your safety, attach an L-shape bracket in addition to the mount bracket kit for the front panel to balance the weight.</p>
---	---

**For devices with rubber feet:**

 <b>Instruction</b>	<p>Never insert only the screws into the holes after removing the rubber feet. It may lead to damage when the screws contact electrical circuit or parts inside of the product. To put the rubber feet back on, use only provided rubber feet and screws.</p>
---	---

**Altitude:**



**Instruction**

Do not place the product at elevations of 2,000 meters (6562 feet) or higher above sea level. Failure to do so may shorten the life of the internal parts and result in malfunctions.

## Table of Contents

1	Included items .....	11
2	Product outline .....	12
3	Features .....	13
4	Panels .....	14
4.1	Front panel .....	14
4.2	Rear panel .....	15
5	Example connection .....	16
6	Precautions .....	17
6.1	Installing rubber feet .....	17
6.2	Installation .....	17
6.3	Cabling .....	18
6.3.1	Cables .....	18
6.3.2	Twisted pair cable .....	19
6.3.3	Connecting audio cables .....	20
6.3.4	Connecting RS-232C cable .....	20
6.3.5	DIN plug AC adapter .....	21
7	Basic operation .....	23
7.1	Required time .....	23
7.2	Switching input channel .....	23
7.2.1	Selecting input channel .....	23
7.2.2	Turning OFF input signal .....	23
7.3	Setting and canceling key lock .....	24
7.4	Initialization .....	25
7.5	PinP (Picuture in Picuture) .....	28
7.6	WEB menu operation .....	28
7.6.1	Control from WEB browser .....	28
7.6.2	WEB menu .....	29
8	Menu .....	30
8.1	WEB menu list .....	30
8.2	Input Signal Automatic Detection .....	32
8.3	Crosspoint operation (WEB menu) .....	34
8.3.1	Selecting input channel (WEB menu) .....	35
8.3.2	PinP output .....	35
8.3.3	Editing channel name .....	36
8.3.4	Setting and canceling key lock (WEB menu) .....	37
8.4	Output timing (WEB menu) .....	38
8.4.1	Output resolution .....	40
8.4.2	Aspect ratio for sink device .....	41
8.4.3	Aspect ratio .....	41
8.4.4	Aspect ratio control .....	42
8.4.5	Overscan .....	42
8.4.6	Display position .....	43
8.4.7	Display size .....	43
8.4.8	Masking .....	44
8.4.9	Automatic sizing .....	45
8.4.10	Background color .....	45
8.4.11	Test pattern .....	45



8.5	Quality settings (WEB menu)	47
8.5.1	Sharpness	49
8.5.2	Brightness	49
8.5.3	Contrast	49
8.5.4	HUE	49
8.5.5	Saturation	50
8.5.6	Black level	50
8.5.7	Gamma	50
8.5.8	Default color	50
8.6	Input settings (WEB menu)	51
8.6.1	No-signal input monitoring	52
8.6.2	Setting HDCP input	52
8.6.3	Input equalizer	53
8.6.4	Automatic detection of input video interruption	53
8.6.5	Priority of input channel automatic switching	54
8.6.6	Masking time after automatic switching of input channel	55
8.7	Input timing (WEB menu)	56
8.7.1	The total number of horizontal dots	57
8.7.2	Start position	57
8.7.3	Active area	58
8.7.4	Input timing initialization	58
8.8	Output settings (WEB menu)	59
8.8.1	Output mode	60
8.8.2	Synchronous signal output with no input video	60
8.8.3	Output video with no input video	61
8.8.4	Window transition effect	61
8.8.5	Window transition speed	61
8.8.6	Wipe color	62
8.8.7	HDCP output	62
8.8.8	The number of HDCP retries	62
8.8.9	Deep Color	63
8.8.10	CEC connection	63
8.8.11	HDCP re-authentication	63
8.9	Audio settings (WEB menu)	64
8.9.1	Output level	66
8.9.2	Output mute	66
8.9.3	Audio output connector	66
8.9.4	Multi channel audio output	67
8.9.5	Test tone	67
8.9.6	Input level	67
8.10	EDID: Extended Display Identification Data (WEB menu)	68
8.10.1	EDID	70
8.10.2	Resolution for PCs	71
8.10.3	Input resolution for AV devices	72
8.10.4	Deep Color	73
8.10.5	Audio format	73
8.10.6	Speaker configuration	74
8.10.7	Copying EDID	75
8.11	Communication settings (WEB menu)	76
8.11.1	RS-232C communication	80

8.11.2	IP address/subnet mask/gate way address.....	80
8.11.3	TCP port number.....	81
8.11.4	MAC address .....	81
8.12	Preset memory (WEB menu) .....	82
8.12.1	Loading cross point .....	83
8.12.2	Saving cross point.....	83
8.12.3	Editing cross point.....	84
8.12.4	Loading all settings .....	84
8.12.5	Saving all settings .....	85
8.12.6	Copying output setting.....	86
8.12.7	Startup setting.....	87
8.13	Setting bitmap (WEB menu).....	88
8.13.1	Sending bitmap file.....	89
8.13.2	Outputting bitmap image .....	90
8.13.3	Background color .....	90
8.13.4	Aspect ratio.....	91
8.13.5	Display position.....	91
8.13.6	Input channel assignment.....	92
8.13.7	Bitmap output at startup .....	92
8.13.8	Dividing memory area .....	92
8.13.9	Input image capture.....	95
8.14	Other settings (WEB menu) .....	96
8.14.1	Startup setting for key lock .....	97
8.14.2	Automatic reload time.....	97
8.14.3	Backup and restore all settings.....	97
8.14.4	Initialization (WEB menu) .....	98
8.14.5	Displaying version .....	98
8.15	Displaying status (WEB menu) .....	99
8.15.1	Input signal status .....	100
8.15.2	Sink device status .....	103
8.15.3	Displaying EDID of sink device.....	105
9	Product specification .....	106
10	Troubleshooting.....	108

# 1 Included items

Make sure all items below are included in the package.  
 If any items are missing or damaged, please contact IDK.

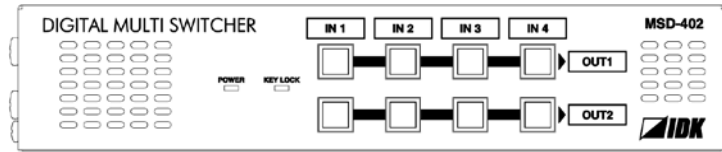

One (1) MSD-402 (main unit)

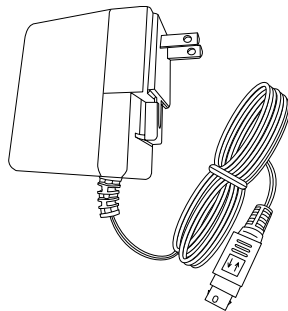

One (1) lockable DIN plug AC adapter

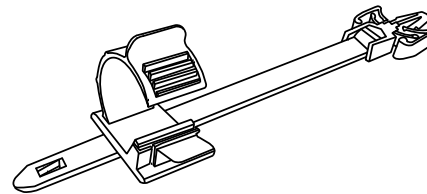

Three (3) cord clamps

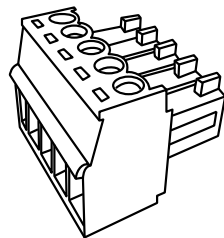

Two (2) terminal Block (5-pin)

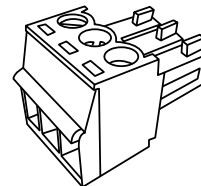

One (1) terminal Block (3-pin)

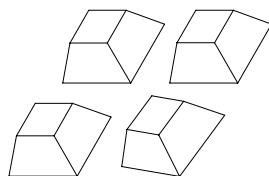

Four (4) rubber feet

**[Figure 1.1] Included items list**

## 2 Product outline

MSD-402 (hereafter referred to as “the MSD”) Presentation Switcher provides 4 inputs and 2 outputs and has a built-in scan converter.

For video input, 2 HDBaseT and 2 HDMI/DVI are included. Input video signals are converted to HDMI/DVI signals or HDBaseT signals output at resolutions up to QWXGA or 1080p.

For audio input, 4 digital inputs are included. Selected audio signals are output to digital audio and analog audio. Audio levels of each input and output can be set individually.

RS-232C and LAN are provided as communication ports for external control communication and web browser to enable you to set menus remotely. HDBaseT input/output supports bidirectional LAN communication.

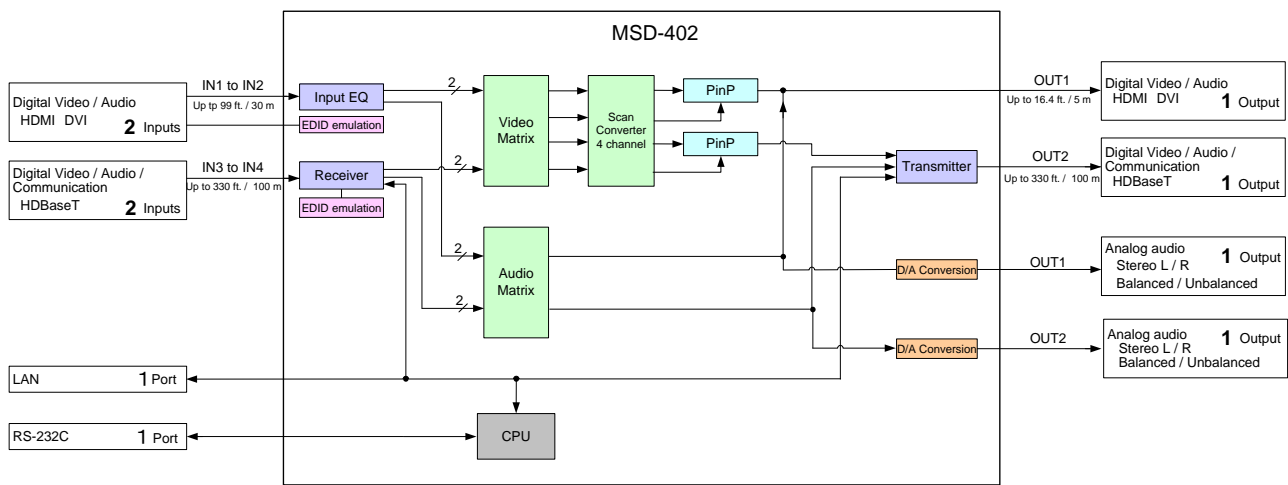

[Figure 2.1] Block diagram

## 3 Features

---

### ■ Video

- Up to QWXGA (RB)<sup>\*1</sup> or 1080p
- HDMI input cable EQ  
    INPUT: up to 33 ft. to 99 ft. approx. / 10 m to 30 m
- Up to 328.08 ft. approx. / 100 m extension over a Cat6 cable
- Scan converter
- Picture in Picture (PinP) function
- Aspect control
- Seamless switching<sup>\*2</sup>
- Anti-snow

### ■ Audio

- Digital audio de-embedded
- Audio level adjustment for each input/output.

### ■ Control input

- RS-232C, LAN

### ■ Others

- EDID emulation (with copy function)
- Web browser for all settings
- Automatic input channel switching
- Crosspoint memory
- Preset memory
- Last memory
- Connection reset
- Key lock
- AC adapter mechanical lock

\*1 (RB) = Reduced Blanking

\*2 A black frame is displayed at the time of switching

## 4 Panels

### 4.1 Front panel

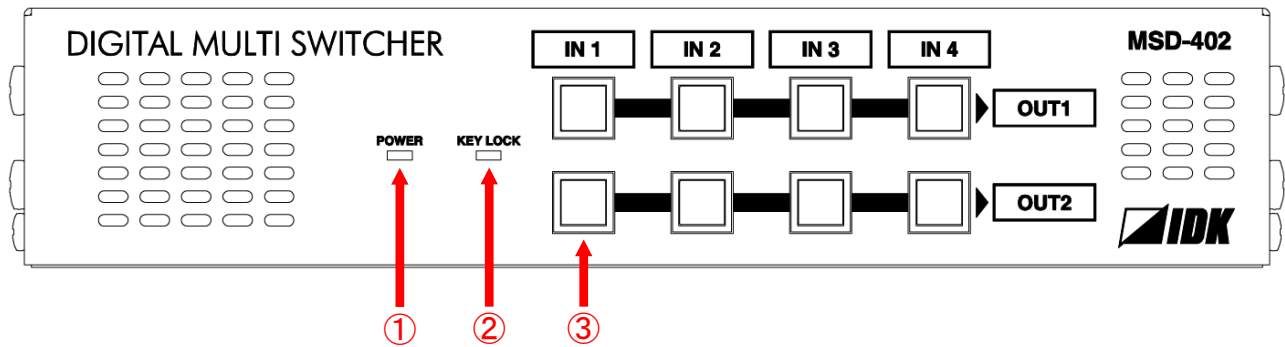

[Figure 4.1] Front panel drawing

[Table 4.1] Front panel's part name and description

#	Part name	Description
①	POWER LED	Shows power status of the MSD ON: Power is supplied to the MSD OFF: Power is not supplied to the MSD
②	KEY LOCK LED	Shows key lock status of the MSD ON: Locked OFF: Unlocked 【See: 7.3 Setting and canceling key lock (P.24)】
③	Input channel selection key	Selects input channels 【See: 7.2 Switching input channel (P.23)】

## 4.2 Rear panel

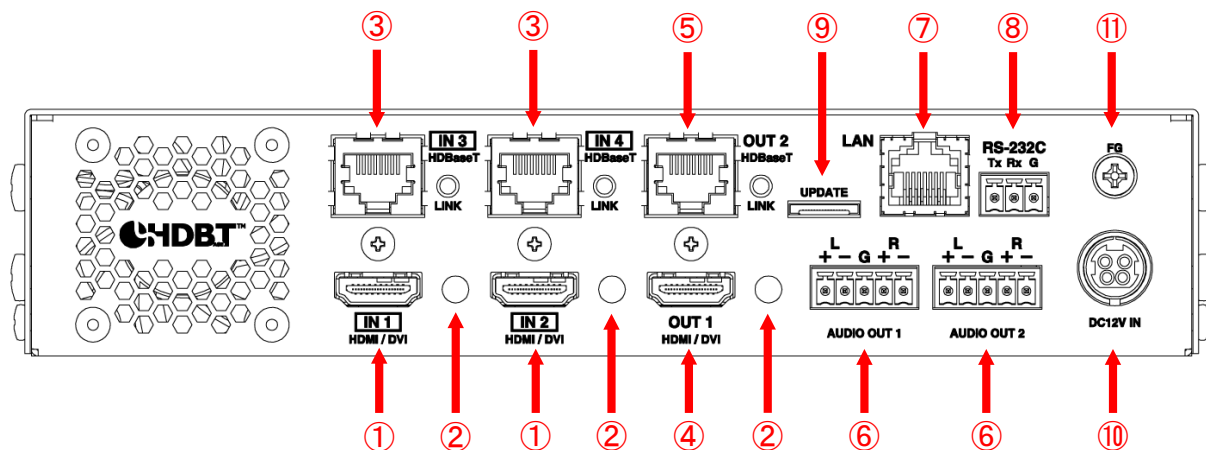

[Figure 4.2] Rear panel drawing

[Table 4.2] Rear panel's part name and description

#	Part name	Description
①	HDMI input connector	Input connectors for HDMI and DVI signal to connect to a source devices, such as Blu-ray players.
②	HDMI cable fixing hole	Fixes HDMI cables by inserting cable clamps. 【See: [Figure 6.1] Attaching a cable clamp (P.18) 】
③	HDBaseT input connector	Digital (video/audio) signal can be extended up to 100 m/328.08 ft. using an IDK's HDC transmitter together. 【See: 6.3.2 Twisted pair cable (P.19) 】
④	HDMI output connector	Output connector for HDMI and DVI signal to connect to sink devices such as LC monitors and projectors
⑤	HDBaseT output connector	Digital (video/audio) signal can be extended up to 100 m/328.08 ft. using an IDK's HDC receiver together. 【See: 6.3.2 Twisted pair cable (P.19) 】
⑥	Audio output connector	Analog output connectors of audio to connect to amplifier, speakers, and mixers. 【See: 6.3.3 Connecting audio cables (P.20) 】
⑦	LAN port	For external control by communication commands or web browsers
⑧	RS-232C port	For external control by communication commands 【See: 6.3.4 Connecting RS-232C cable (P.20) 】
⑨	Maintenance port	Not used. Keep this connector free
⑩	DC power connector	Connects attached AC adapter 【See: 6.3.5 DIN plug AC adapter (P.21) 】
⑪	Frame ground	For indoor ground terminal. M4 screws are used.

## 5 Example connection

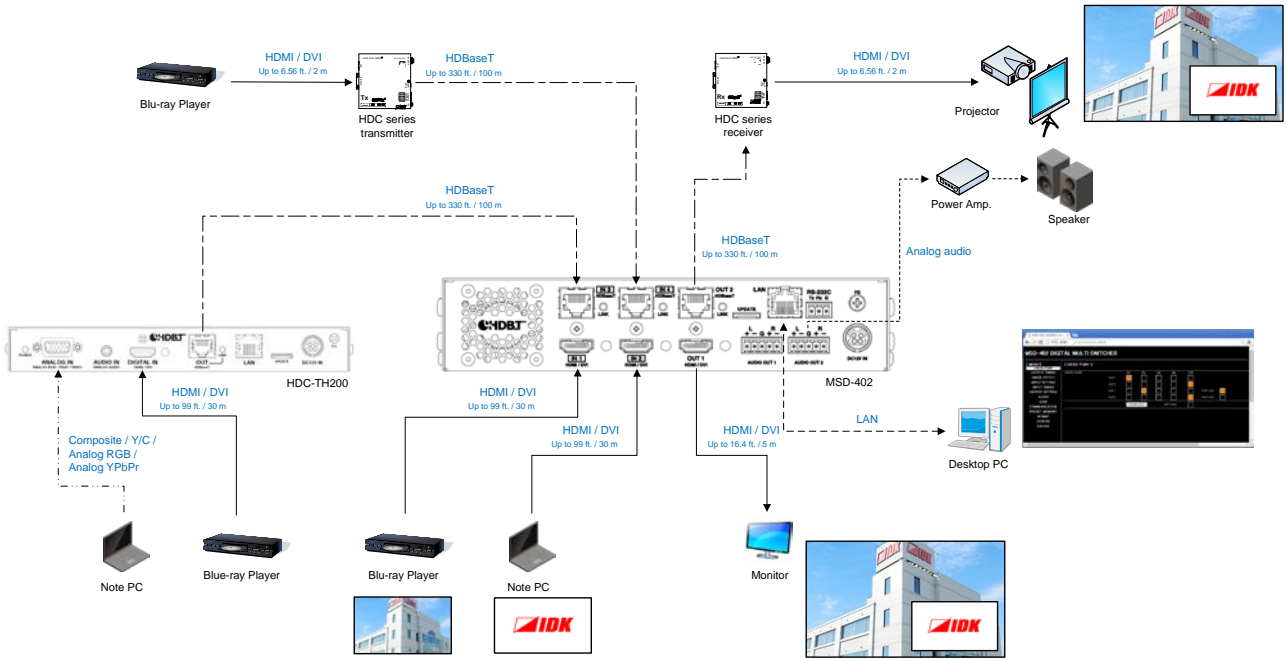

[Figure 5.1] Source and sink devices are connected



## 6 Precautions

---

Before connecting to external devices, follow the precautions below.

### 6.1 Installing rubber feet

---

Please clean up the MSD main unit, and then install rubber feet to the four corners of the MSD.

### 6.2 Installation

---

When installing the MSD, please observe the following precautions.

- Do not place the MSD on top of another MSD.
- Do not block vent holes. Please secure the space above ambient 30 mm/1.18 inches.
- Do not install the MSD to an enclosed space. When the MSD needs to be installed to EIA rack mount or an enclosed space, please prepare ventilating equipment to keep the ambient temperature at 40 degrees C/104 degrees F or less. If inadequately vented, the life of parts may be shortened and operations may be affected.

## 6.3 Cabling

When connecting the MSD to the external devices, please observe the following precautions.

- Read manuals of the external devices.
- Before you connect the cable to the MSD or an external device, please remove electrification of the body by touching the metal around that is grounded.
- Turn off all units power before connecting the cable.
- Be sure to plug cables completely and install them without any stress on connectors.
- Fix HDMI cables using cable clamps to prevent those cables from falling off.

### Fixing HDMI cable using cable clamp

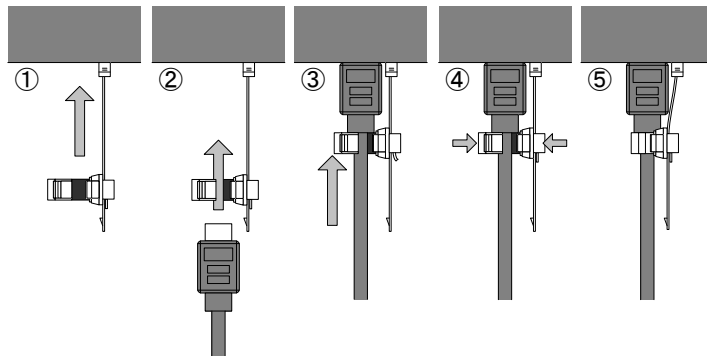

### Removing HDMI cable and cable clamp

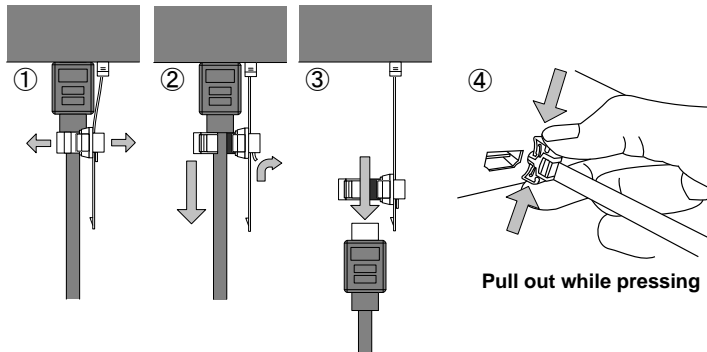

**[Figure 6.1] Attaching a cable clamp**

### 6.3.1 Cables

IDK Corporation provides various digital cables such as HDMI, DVI, and twisted pair cables.

Please choose appropriate cables for your system configuration. For analog audio and RS-232C, please use on processing the cable to fit the connectors.

【See: 6.3.3 Connecting audio cables (P.20) 】  
 【See: 6.3.4 Connecting RS-232C cable (P.20) 】

## 6.3.2 Twisted pair cable

When connecting twisted pair cables to the MSD, please observe the following precautions.

- Cat5e/Cat6 UTP/STP can be used, however, we recommend a CAT.5E HDC cable\* for the twisted pair cable which is developed by IDK to maximize quality of video transmission.
- If using an STP cable, connect the FG connector to an earth ground source. Otherwise, the shielding feature does not work correctly. When using a UTP cable, we still recommend using the ground connector.
- The shielded STP cables are less affected by interference or external noise than UTP cables.
- The connector for twisted pair cable is as same as the connectors which are used for Ethernet (8 core modular type connector), however, it cannot be connected and use for Ethernet because the way of data transmission is different.
- The maximum extension distance of Cat5e/Cat6 UTP/STP cable is the shorter maximum extension distance of the connected HDC receiver and sink device.
- For pin assignments, apply T568A or T568B standards for straight through wiring.
- Do not give connection cables a strong pull. The allowable tension of the twisted pair cable is 110 N.
- Do not bend the connection cable at a sharp angle. Keep the bend radius four times of the cable diameter or longer.
- Do not tie the cable tightly; leave a space allowing the cable to move slightly.
- If you use the same cables, we recommended keeping a distance between the cables or not to place the cables closely in parallel.
- Keep the twisted pair cable as straight as you can. If you coil the cable, it is easily affected by noise.
- Do not place this product in an electrically noisy environment, since high-speed signal is transmitted. Particularly when you use a high-output radio around this device, video or audio may be interrupted.
- If the distance between the transmitter and receiver is 100 m/328.08 feet or less, cables can be joined using an RJ-45 plug coupler or wall outlet. Up to two cable couplers are allowed. Couplers supporting Cat6A (10GBase-T) are recommended.
- [Figure 6.2] show extension distance by each twisted pair cable. The extension distance depending on installation environment.

**[Figure 6.2] Twisted pair cable extension distance**

External noise	Category		Distance	Dot clock	Memo
Affected	UTP	Cat5e	50 m/164.04 ft.	<= 225 MHz	IDK recommends Cat5e STP, Cat6 UTP/STP, or CAT.5E HDC cable* if the extension distance exceeds 50 m/164.04 ft.
		Cat6	100 m/328.08 ft.		
Less affected	STP	Cat5e*	100 m/328.08 ft.		
		Cat6			

\* CAT.5E HDC cable developed by IDK Corporation is double shielded twisted pair cable for high quality video transmission. It protects video signals from external noise or other interferences by having double shielded structure. Its transmission characteristic meets 500 MHz up to 100 m/328.08 ft., and it is certified and recommended by HDBaseT alliance.

**[NOTE]** If there is a problem in the transmission path, video or audio may be interrupted. Please check the items above. If the problem still cannot be solved, shorten the length of the twisted pair cable.

### 6.3.3 Connecting audio cables

Please fix audio cable to the attached terminal block (5-pin), and then connecting to the MSD.

The MSD supports both balanced and unbalanced signals

IDK recommends using AWG 28 to AWG16 cable. The maximum peeling length is 7 mm (0.28 inch approx.)

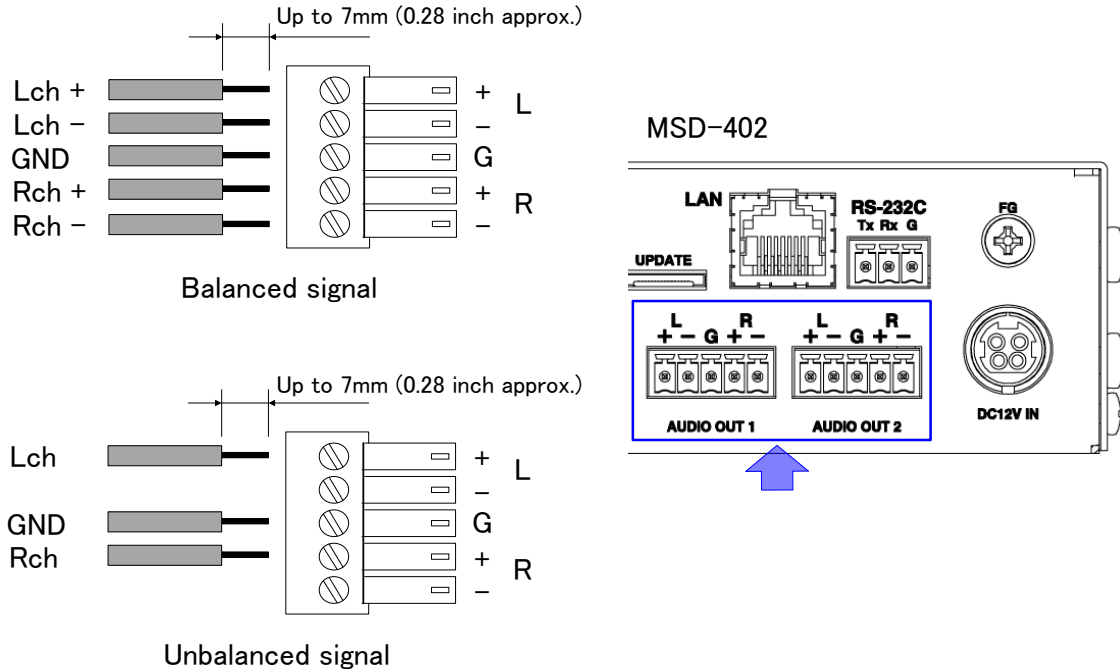

[Figure 6.3] Connecting audio cable to terminal block (5-pin) connector

### 6.3.4 Connecting RS-232C cable

Please fix RS-232C cable to the attached terminal block (3-pin), and then connecting to the MSD.

IDK recommends using AWG 28 to AWG16 cable. The maximum peeling length is 7 mm (0.28 inch approx.)

If you connect to the MSD using conversion cable from D-sub connector (9-pin) cable, please short RTS/CTS and DTR/DSR if necessary.

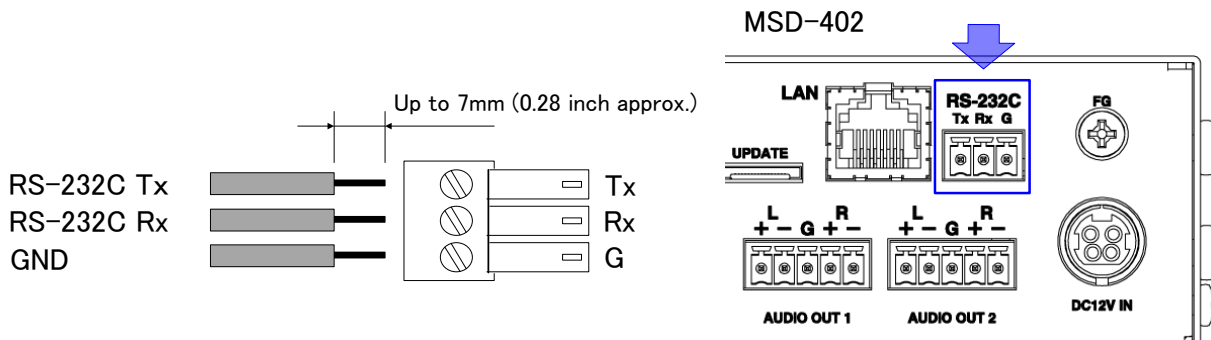

[Figure 6.4] Connecting RS-232C cable to terminal block (3-pin) connector

## 6.3.5 DIN plug AC adapter

### ■ Attaching/removing AC plug

The AC plug for DIN plug AC adapter is different by each country. Please use appropriate AC plug.

#### Removing:

Removes AC plug by sliding AC plug from AC adapter main unit whole holding down the partial knob.

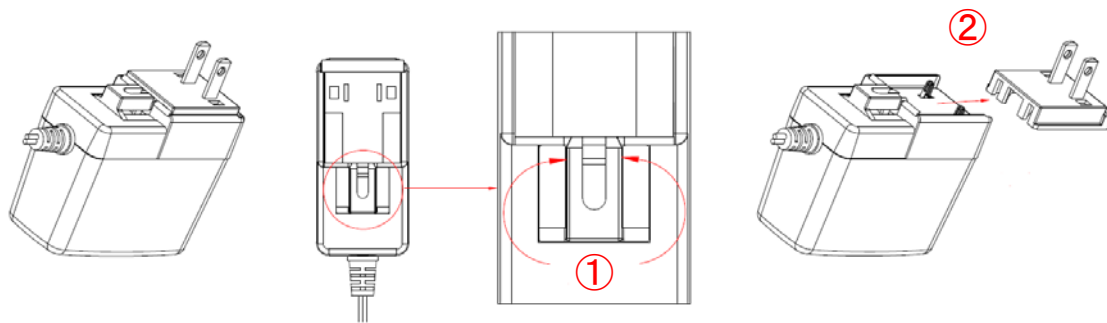

[Figure 6.5] Removing AC plug

#### Attaching:

Slides in an AC plug to the AC adapter.

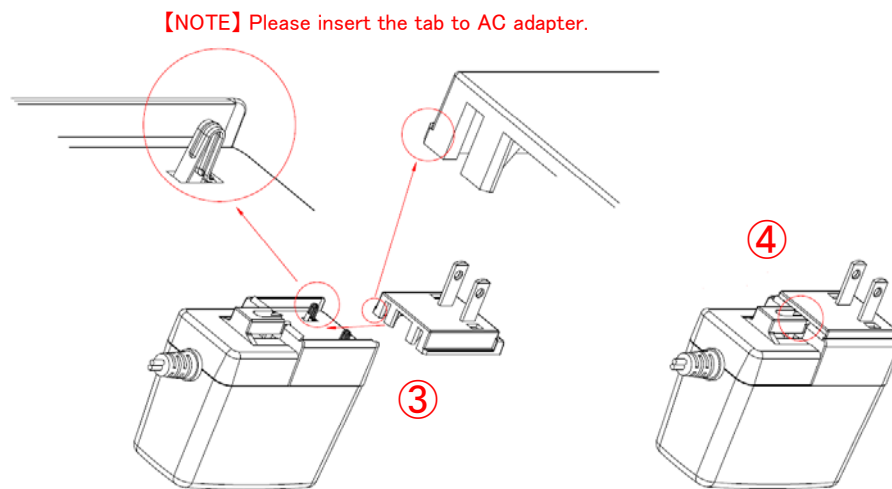

[Figure 6.6] Attaching AC plug

■ **Connecting DC plug**

Please connect DC plug to the MSD until you can hear small sound of fixing. When you disconnect DC plug from the MSD, please hold the part which is specified in following figure.

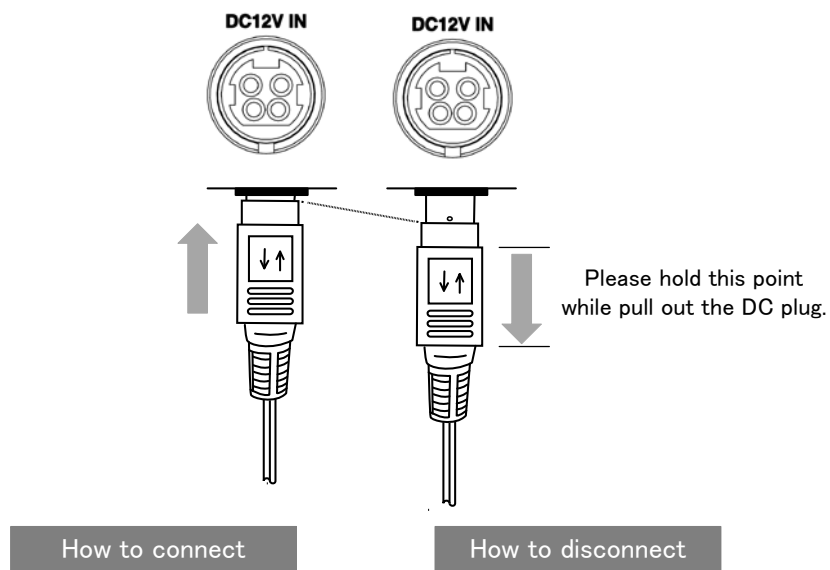

[Figure 6.7] Connecting DC plug

## 7 Basic operation

### 7.1 Required time

The MSD turns on when AC adapter is connected and power is supplied. All LEDs except POWER LED turn on until the MSD is ready. After the MSD is turned on, it takes few seconds to take next operation.

[Table 7.1] Required time

Operation	Required time
Receiving communication command	6 or longer seconds
Receiving operation of front panel	9 or longer seconds
Receiving WEB browser operation	7 or longer seconds

[NOTE] If "8.13.7 Bitmap output at startup (P.92)" is set to "ON", the required time may be longer.

### 7.2 Switching input channel

#### 7.2.1 Selecting input channel

Selects input channel for video and audio which output from each output channel.

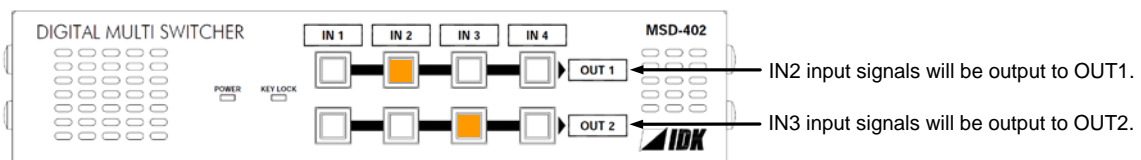

[Figure 7.1] Select input channel

#### 7.2.2 Turning OFF input signal

You can turn OFF the input signal by pressing the input key that is currently selected. You can switch output the input signal or turn off the input signal by toggle operation.

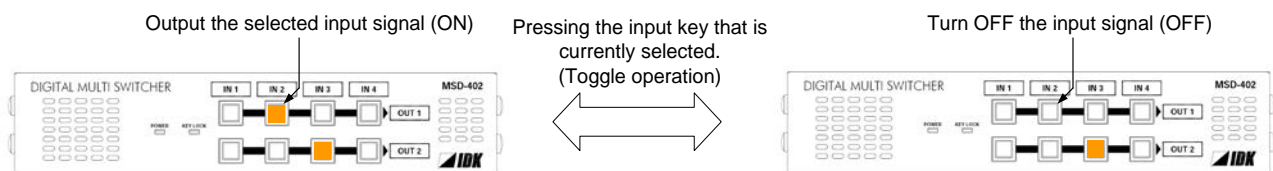

[Figure 7.2] Turn OFF input signal

You can select input channel from WEB browser menu.

【See: 8.3.1 Selecting input channel (WEB menu) (P.35)】

## 7.3 Setting and canceling key lock

Key lock operation is assigned to "IN 1" key at OUT 1. You can lock/ cancel keys by pressing "IN 1" key at OUT 1 two or longer seconds. If the MSD's keys are locked, KEY LOCK LED is ON. If key lock is canceled, KEY LOCK LED is OFF.

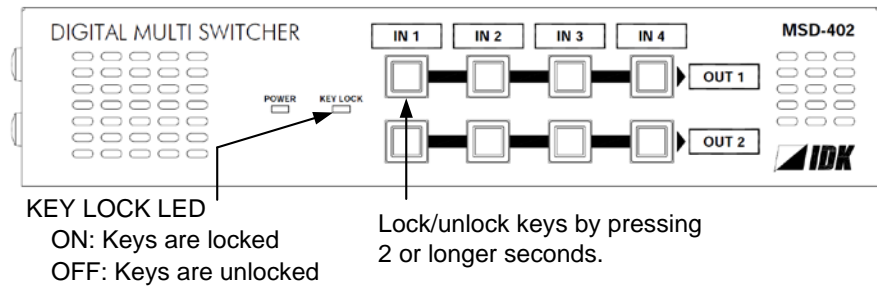

**[Figure 7.3] Key lock**

You can set and cancel key lock from WEB browser menu.

【See: 8.3.4 Setting and canceling key lock (WEB menu) (P.37)】



## 7.4 Initialization

Initialization operation is assigned to "IN 1" key at OUT 1. You can initialize the MSD by turning on while pressing "IN 1" key at OUT 1. Please keep pressing "IN 1" key at OUT 1 until LEDs except POWER LED start blinking. Those LEDs become OFF, it means initialization is done and starts normal operation.

You can initialize setting from WEB browser menu.

【See: 8.14.4 Initialization (WEB menu) (P.98)】

**[Table 7.2] Factory default settings (1/3)**

Function	Factory default setting	Page
<b>Input channel</b>		
Switching input channel	OFF	23
PinP output	OFF	35
Editing channel name	INPUT1 : IN1 INPUT2 : IN2 INPUT3 : IN3 INPUT4 : IN4 OUTPUT1 : OUT1 OUTPUT2 : OUT2 PinPOUT1 : PinP1 PinPOUT2 : PinP2	36
Setting and canceling key lock	OFF	24
<b>Setting position, size, and masking</b>		
Output resolution	AUTO (automatically set by EDID)	40
Aspect ratio for sink device	RESOLUTION (aspect ratio of output resolution)	41
Aspect ratio	AUTO-1	41
Aspect ratio control	LETTER BOX or SIDE PANEL	42
Overscan	NTSC/PAL/SDTV: 105% HDTV/PC: 100%	42
Input Display position	Horizontal / Vertical: 0	43
Input Display size	Horizontal / Vertical: The number of pixel of output resolution	43
Input Masking	Left / Top: 0 Right / Bottom: The number of pixel of output resolution (no masking)	44
Output Display position	Horizontal / Vertical: 0	43
Output Display size	Horizontal / Vertical: The number of pixel of output resolution	43
Output Masking	Left / Top: 0 Right / Bottom: The number of pixel of output resolution (no masking)	44
Background color	R / G / B: 0 (black)	45
Test pattern	OFF	45

**[Table 7.3] Factory default settings (2/3)**

Function	Factory default setting	Page
<b>Setting position, size, and masking</b>		
Sharpness	0	49
Input Brightness	100%	49
Input Contrast	R / G / B: 100%	49
HUE	0°	49
Saturation	100%	50
Black level	±0.0%	50
Output Brightness	100%	49
Output Contrast	R / G / B: 100%	49
Gamma	1.0	50
<b>Input settings</b>		
No-signal input monitoring	10000ms (10 seconds)	52
Setting HDCP input	ENABLE	52
Input equalizer	ON	53
Automatic detection of input video interruption	ON	53
Priority of input channel automatic switching	All input channel's priorities: OFF	54
Masking time after automatic switching of input channel	0s000ms (masking: OFF)	55
<b>Input timing</b>		
Horizontal Start position	0 (automatically set up if signal is input)	57
Horizontal Active area	0 (automatically set up if signal is input)	58
Vertical Start position	0 (automatically set up if signal is input)	57
Vertical Active area	0 (automatically set up if signal is input)	58
<b>Output settings</b>		
Output mode	HDMI YCbCr4:4:4 MODE (Output appropriate mode depending on connected sink device.)	60
Synchronous signal output with no input video	ON	60
Output video with no input video	BLUE	61
Window transition effect	FREEZE→FADE OUT-IN	61
Window transition speed	350ms	61
Wipe color	R / G / B: 0 (black)	62
HDCP output	ALWAYS	62
The number of HDCP retries	ETERNITY (retrying until success)	62
Deep Color	24-BIT COLOR	63
CEC connection	NOT CONNECTED	63
<b>Audio settings</b>		
Output level	±0dB	66
Output mute	OFF	66
Input level	±0dB	67
Audio output connector	ANALOG&DIGITAL	66
Multi channel audio output	DOWN MIX	67

Test tone	OFF	67
-----------	-----	----

**[Table 7.4] Factory default settings (3/3)**

Function	Factory default setting	Page
<b>EDID</b>		
EDID	INTERNAL EDID	70
Resolution for PCs	1080p (1920x1080)	71
Input resolution for AV devices	AUTO	72
Deep Color	24-BIT COLOR	73
Audio format	Linear PCM 48kHz	73
Speaker configuration	2ch (Front Left / Front Right)	74
Copying EDID	Not registered	75
<b>RS-232C communication settings</b>		
Baud rate	9600bps	80
Data bit length	8bit	80
Parity check	NONE	80
Stop bit	1bit	80
<b>LAN communication settings</b>		
IP address	192.168.1.199	80
Subnet mask	255.255.255.0	80
Gateway address	192.168.1.200	80
TCP port number	Connection 1 to 3: 1100 Connection 4 to 6: 23 Connection 7 to 8: 80	81
<b>Preset memory</b>		
Saving cross point	Not registered	83
Saving all settings	Not registered	85
Startup setting	Starting with the settings when you turn off power last time.	87
<b>Setting bitmap</b>		
Outputting bitmap image	OFF	90
Background color	R / G / B: 255 (white)	90
Aspect ratio	AUTO	91
Display position	CENTER	91
Input channel assignment	OFF (no assignment)	92
Bitmap output at startup	OFF	92
Dividing memory area	Division: None Memory size: bitmap1 has been assigned 128 blocks	92
<b>Other settings</b>		
Startup setting for key lock	AUTO (Starting with the settings when you turn off power last time.)	97
Automatic reload time	OFF (no automatic reload)	97

## 7.5 PinP (Picture in Picture)

The MSD has PinP (Picture in Picture) output function. Each output channel can have one overlay.



[Figure 7.4] PinP output

PinP output setting can be adjusted in “8.3.1 Selecting input channel (WEB menu) (P.3535)”, “8.4 Output timing (WEB menu) (P.38)”, “8.5 Quality settings (WEB menu) (P.47)”, and “8.8 Output settings (WEB menu) (P.59)”.

---

**【NOTE】** You can enable and adjust PinP output from WEB browser operation or control command communication. For details, please see “7.6 WEB menu operation (P.28)” and “Command Guide”.

---

## 7.6 WEB menu operation

All settings of the MSD can be done from WEB browser menu operation.

JavaScript is used for the MSD WEB browser. When you set the MSD from WEB browser menu, please enable JavaScript before setting up. Please confirm each browser's help menu if you do not know how to enable JavaScript.

---

**【FYI】** IDK confirms and tests following environment

OS	:	Windows 7 Professional
WEB browser	:	Microsoft Internet Explorer 11
		Google Chrome 51
		Mozilla Firefox 47

---

### 7.6.1 Control from WEB browser

You can control the MSD via LAN from a web browser, such as Microsoft Internet Explorer. Type the IP address that is set to the MSD in the address bar to open the operation window.

【See: 8.11.2 IP address/subnet mask/gate way address (P.80)】

【See: 8.11.3 TCP port number (P.81)】

[Table 7.5] Input example

Control port number of web browser	IP address
80 (Normal)	http://192.168.1.199
Other than 80 (5000 to 5999)	http://192.168.1.199:5000 (ex: 5000)

## 7.6.2 WEB menu

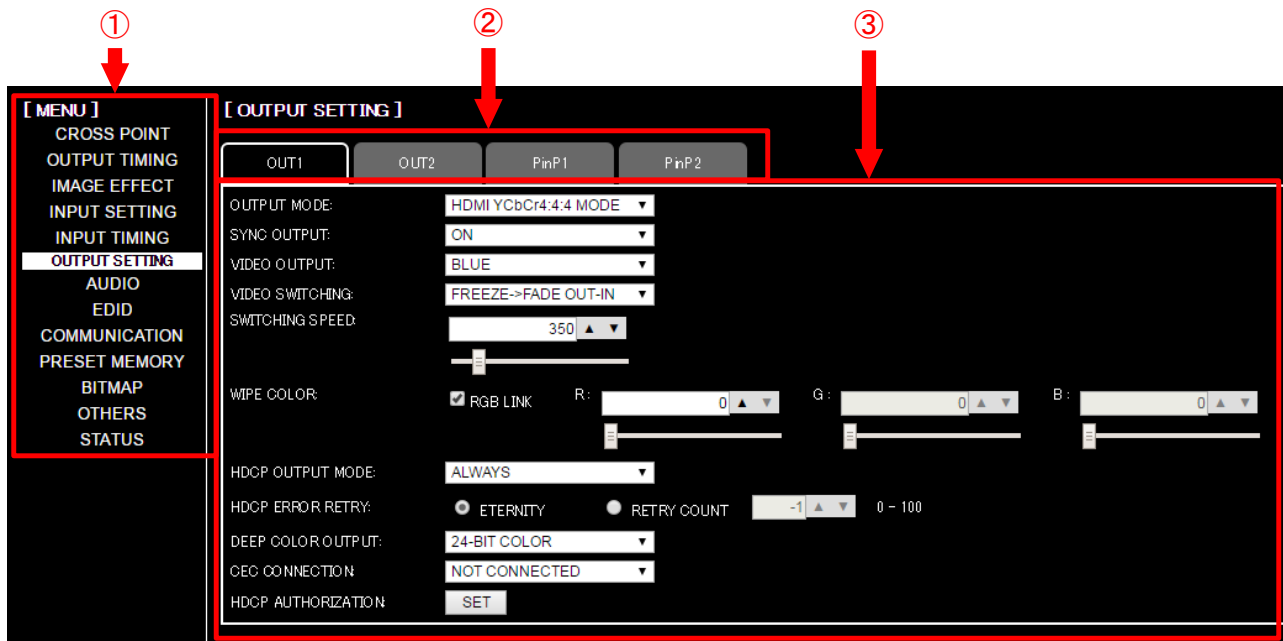

[Figure 7.5] WEB menu

- ① Selected [MENU] page is displayed to right side
- ② There are menu that can switch channels for setting  
You can edit channel name which is displayed into tab.  
【See: 8.3.3 Editing channel name (P.36)】
- ③ Menu items are displayed according to selected tab.  
Controls which are used in menu, please see following “[Table 7.6] Controlling menu”.

[Table 7.6] Controlling menu

Display example	Control	Discription
	Set/execution key	You can execute operation according to the menu item by pressing set/execution key.
	Pull down list	You can select a setting value from multiple setting values.
	Arrow key	You can select a setting value from the range. You can also set a value by input value directly.
	Slider bar	You can select a setting value from the wide range.
	Check box	You can enable a function by checking the box. Check box is used for multiple setting values also.
	Radio button	You can select a setting value from multiple setting values.

## 8 Menu

### 8.1 WEB menu list

【See: 7.6 WEB menu operation (P.28)】

#### 8.3 Crosspoint operation (WEB menu) (P.34)

<b>[MENU]</b>	<b>[CROSS POINT]</b>
<b>CROSS POINT</b>	CROSS POINT
OUTPUT TIMING	PinP ON
IMAGE EFFECT	NAME EDIT
INPUT SETTING	KEY LOCK
INPUT TIMING	
OUTPUT SETTING	
AUDIO	
EDID	
COMMUNICATION	
PRESET MEMORY	
BITMAP	
OTHERS	
STATUS	

#### 8.6 Input settings (WEB menu) (P.51)

<b>[MENU]</b>	<b>[INPUT SETTING]</b>
CROSS POINT	INPUT VIDEO DETECT
OUTPUT TIMING	HDCP INPUT ENABLE
IMAGE EFFECT	INPUT EQUALIZER
<b>INPUT SETTING</b>	INPUT OFF CHECK
INPUT TIMING	AUTO SWITCHING ON
OUTPUT SETTING	AUTO SWITCHING OFF
AUDIO	AUTO SWITCHING MASK
EDID	
COMMUNICATION	
PRESET MEMORY	
BITMAP	
OTHERS	
STATUS	

#### 8.4 Output timing (WEB menu) (P.38)

<b>[MENU]</b>	<b>[OUTPUT TIMING]</b>
CROSS POINT	RESOLUTION
<b>OUTPUT TIMING</b>	MONITOR ASPECT
IMAGE EFFECT	ASPECT
INPUT SETTING	ASPECT PROCESS
INPUT TIMING	OVER SCAN
OUTPUT SETTING	POSITION
AUDIO	SIZE
EDID	MASKING
COMMUNICATION	AUTO SIZING
PRESET MEMORY	BACKGROUND COLOR
BITMAP	TEST PATTERN
OTHERS	
STATUS	

#### 8.7 Input timing (WEB menu) (P.56)

<b>[MENU]</b>	<b>[INPUT TIMING]</b>
CROSS POINT	H TOTAL DOT
OUTPUT TIMING	START POSITION
IMAGE EFFECT	DISPLAY
INPUT SETTING	INITIALIZE
<b>INPUT TIMING</b>	
OUTPUT SETTING	
AUDIO	
EDID	
COMMUNICATION	
PRESET MEMORY	
BITMAP	
OTHERS	
STATUS	

#### 8.5 Quality settings (WEB menu) (P.47)

<b>[MENU]</b>	<b>[IMAGE EFFECT]</b>
CROSS POINT	SHARPNESS
OUTPUT TIMING	BRIGHTNESS
<b>IMAGE EFFECT</b>	CONTRAST
INPUT SETTING	HUE
INPUT TIMING	SATURATION
OUTPUT SETTING	SETUP LEVEL
AUDIO	GAMMA
EDID	DEFAULT COLOR
COMMUNICATION	
PRESET MEMORY	
BITMAP	
OTHERS	
STATUS	

#### 8.8 Output settings (WEB menu) (P.59)

<b>[MENU]</b>	<b>[OUTPUT SETTING]</b>
CROSS POINT	OUTPUT MODE
OUTPUT TIMING	SYNC OUTPUT
IMAGE EFFECT	VIDEO OUTPUT
INPUT SETTING	VIDEO SWITCHING
INPUT TIMING	SWITCHING SPEED
<b>OUTPUT SETTING</b>	WIPE COLOR
AUDIO	HDCP OUTPUT MODE
EDID	HDCP ERROR RETRY
COMMUNICATION	DEEP COLOR OUTPUT
PRESET MEMORY	CEC CONNECTION
BITMAP	HDCP AUTHORIZATION
OTHERS	
STATUS	

【Figure 8.1】 WEB menu list (1 / 2)

**8.9 Audio settings (WEB menu) (P.64)**

<b>[MENU]</b> CROSS POINT OUTPUT TIMING IMAGE EFFECT INPUT SETTING INPUT TIMING OUTPUT SETTING <b>AUDIO</b> EDID COMMUNICATION PRESET MEMORY BITMAP OTHERS STATUS	<b>[AUDIO]</b> OUTPUT AUDIO LEVEL OUTPUT MUTE OUTPUT CONNECTER MULTI AUDIO TEST TONE INPUT AUDIO LEVEL
--	--

**8.13 Setting bitmap (WEB menu) (P.88)**

<b>[MENU]</b> CROSS POINT OUTPUT TIMING IMAGE EFFECT INPUT SETTING INPUT TIMING OUTPUT SETTING AUDIO EDID COMMUNICATION PRESET MEMORY <b>BITMAP</b> OTHERS STATUS	<b>[BITMAP]</b> SEND BITMAP BITMAP OUTPUT BACKGROUND COLOR ASPECT POSITION CHANNEL ASSIGN POWER ON BITMAP DIVIDE MEMORY VIDEO CAPTURE
--	--

**8.10 EDID (WEB menu) (P.68)**

<b>[MENU]</b> CROSS POINT OUTPUT TIMING IMAGE EFFECT INPUT SETTING INPUT TIMING OUTPUT SETTING AUDIO <b>EDID</b> COMMUNICATION PRESET MEMORY BITMAP OTHERS STATUS	<b>[EDID]</b> EDID DATA PC RESOLUTION AV RESOLUTION DEEP COLOR INPUT AUDIO FORMAT SPEAKER MONITOR EDID COPY
--	--

**8.14 Other settings (WEB menu)(P.96)**

<b>[MENU]</b> CROSS POINT OUTPUT TIMING IMAGE EFFECT INPUT SETTING INPUT TIMING OUTPUT SETTING AUDIO EDID COMMUNICATION PRESET MEMORY BITMAP <b>OTHERS</b> STATUS	<b>[OTHERS]</b> STARTUP KEY LOCK AUTO RELOAD TIME BACKUP/RESTORE INITIALIZE VERSION
--	--

**8.11 Communication settings (WEB menu) (P.76)**

<b>[MENU]</b> CROSS POINT OUTPUT TIMING IMAGE EFFECT INPUT SETTING INPUT TIMING OUTPUT SETTING AUDIO EDID <b>COMMUNICATION</b> PRESET MEMORY BITMAP OTHERS STATUS	<b>[COMMUNICATION]</b> RS-232C BAUD RATE DATA BIT LENGTH PARITY STOP BIT LAN IP ADDRESS SUBNET MASK GATEWAY ADDRESS PORT NUMBER MAC ADDRESS
--	--

**8.15 Displaying status (WEB menu) (P.99)**

<b>[MENU]</b> CROSS POINT OUTPUT TIMING IMAGE EFFECT INPUT SETTING INPUT TIMING OUTPUT SETTING AUDIO EDID COMMUNICATION PRESET MEMORY BITMAP OTHERS <b>STATUS</b>	<b>[STATUS]</b> INPUT STATUS MONITOR STATUS EDID STATUS
--	--

**8.12 Preset memory (WEB menu) (P.82)**

<b>[MENU]</b> CROSS POINT OUTPUT TIMING IMAGE EFFECT INPUT SETTING INPUT TIMING OUTPUT SETTING AUDIO EDID COMMUNICATION <b>PRESET MEMORY</b> BITMAP OTHERS STATUS	<b>[PRESET MEMORY]</b> LOAD CROSS POINT SAVE CROSS POINT EDIT CROSS POINT LOAD ALL SETTING SAVE ALL SETTING COPY OUTPUT MEMORY STARTUP
--	---

**[Figure 8.2] WEB menu list (2 / 2)**

■ Setting/default values

Some menus can be set for each input or output, and each setting range is mentioned in the each menu description.

**[Table 8.1] Setting range**

Setting range	Description
Each output channel	Can be set for each output channel.
Each output channel, each bitmap	Can be set for each output channel and each bitmap.
Each PinP output	Can be set for each PinP output.
Each input channel, each input signal	Can be set for each input channel's input signal.
Each input channel	Can be set for each input channel.
Each connection	Can be set for each connection separately.
Each command	Can be set for each command.

## 8.2 Input Signal Automatic Detection

The MSD continuously monitors input signal. If input signal that have been input before, they are output with the same size and quality of view used previously. If input signal is not matched with any signal that have been input before, only settings of input timing is initialized and other settings are not changed. Adjust the size and quality of view as necessary.

【See: 8.4 Output timing (WEB menu) (P.38)】

【See: 8.5 Quality settings (WEB menu) (P.47)】

【See: 8.7 Input timing (WEB menu) (P.56)】

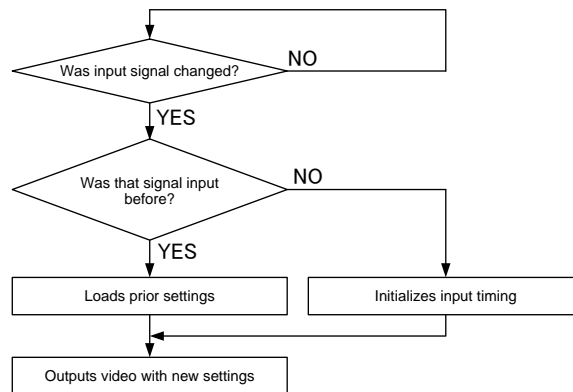

**[Figure 8.3] How signal is recognized**



The MSD saves data of 50 input devices for each channel, and the data is used to check whether the input signal have been input before or not. To save the data of the 51st device, the oldest data that have not been input recently will be deleted, instead.

	IN1	IN2	IN3	IN4	IN5	IN6	IN7	IN8	IN9
1	1080i	1080i	UXGA	UXGA	WXGA	NTSC	NTSC	WXGA	UXGA
2	720p	480i	WXGA	VGA	SVGA	XGA	WXGA	720p	720p
3	480i		SXGA+						
4	XGA								
5	SXGA								
6	UXGA								
⋮									
49	VGA								
50	1080p								

↑  
When new signals are input, the oldest data will be overwritten.

Memory area for 50 devices per channel

**[Figure 8.4] Memory table per channel**

The following items are saved for each input signal.

**[Table 8.2] Items saved for each input signal**

Setting	Item
Output timing (WEB menu)	Aspect ratio, Aspect ratio control, Overscan Display position, Display size, Masking
Quality settings (WEB menu)	Sharpness, Brightness, Contrast, HUE, Saturation, Black level
Input timing (WEB menu)	Start position, Active area
Audio settings (WEB menu)	Input level

### 8.3 Crosspoint operation (WEB menu)

You can set input/output related settings from this page. You can also set PinP output ON / OFF setting and key lock.

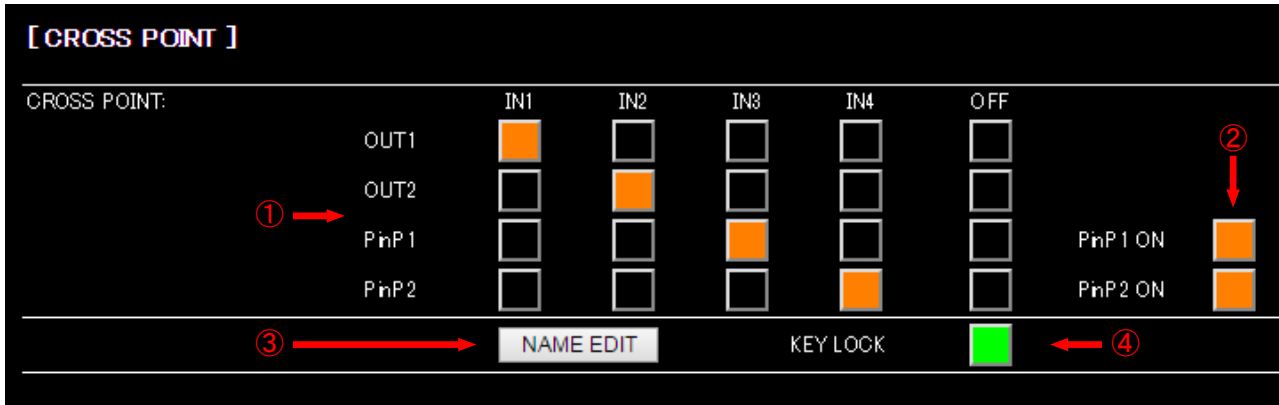

[Figure 8.5] Crosspoint page

- ① 8.3.1 Selecting input channel (WEB menu) (P.35)
- ② 8.3.2 PinP output (P.35)
- ③ 8.3.3 Editing channel name (P.36)
- ④ 8.3.4 Setting and canceling key lock (WEB menu) (P.37)

### 8.3.1 Selecting input channel (WEB menu)

---

Menu	CROSS POINT → CROSS POINT
Setting for	Each output channel, each PinP output
Setting values	
OUT1	: IN1, IN2, IN3, IN4, OFF [Default]
OUT2	: IN1, IN2, IN3, IN4, OFF [Default]
PinP1	: IN1, IN2, IN3, IN4, OFF [Default]
PinP2	: IN1, IN2, IN3, IN4, OFF [Default]

Selects input channel for video and audio output. Input channel can select from front panel keys also.

PinP output cannot select from front panel keys.

【See: 7.2 Switching input channel (P.23)】

### 8.3.2 PinP output

---

Menu	CROSS POINT → CROSS POINT
Setting for	Each PinP output
Setting values	OFF [Default], ON

You can turn ON / OFF PinP output.

### 8.3.3 Editing channel name

Menu CROSS POINT → CROSS POINT

Setting for Input: each input channel  
 Output: each output channel  
 PinP: each PinP output

Setting values [Table 8.3] Editing channel name

By pressing “NAME EDIT” button, following page is displayed and you can set and edit input and output channel name. You can register up to 10 half-width alphanumeric characters to each channel name. Edited channel names are reflects to other web pages.

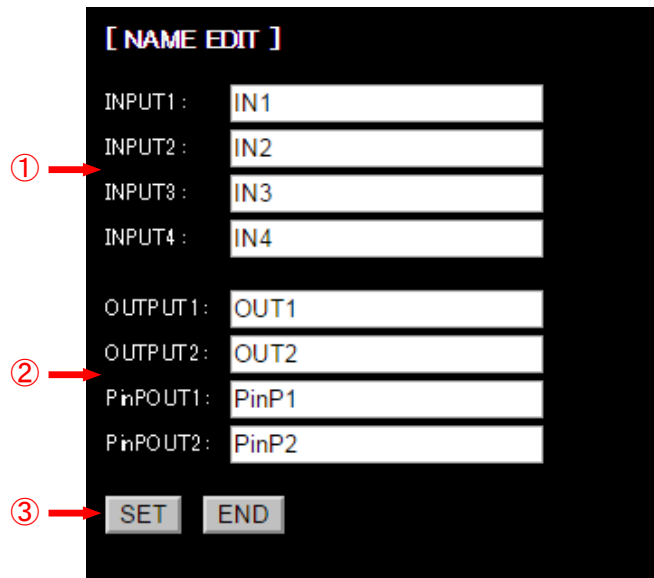

[Figure 8.6] Editing channel name

- ① Input channel name
- ② Output channel name
- ③ “SET” key : Registering input/output/PinP name  
 “END” key : Closing this page and return to CROSS POINT page

[Table 8.3] Editing channel name

Editable items	Default
INPUT1	IN1
INPUT2	IN2
INPUT3	IN3
INPUT4	IN4
OUTPUT1	OUT1
OUTPUT2	OUT2
PinPOUT1	PinP1
PinPOUT2	PinP2

### 8.3.4 Setting and canceling key lock (WEB menu)

---

Menu  CROSS POINT → CROSS POINT

Setting values OFF [Default], ON

By pressing "KEY LOCK" button, you can lock the MSD's front panel keys. "KEY LOCK" button is "ON" when front panel keys are locked. By pressing "KEY LOCK" button again, you can cancel key lock. "KEY LOCK" button is "OFF" when front panel keys are unlocked. You can set and cancel key lock from front panel key.

【See: 7.3 Setting and canceling key lock (P.24)】

## 8.4 Output timing (WEB menu)

You can set output timing from this page and select channel which you want to set from each tab. Position, size, and masking can be set for input side and output side. Normally, set them for input side. If edges are cut off due to enlarged display in the sink device side or if enlarging output video for all inputs at once, set them for the output side.

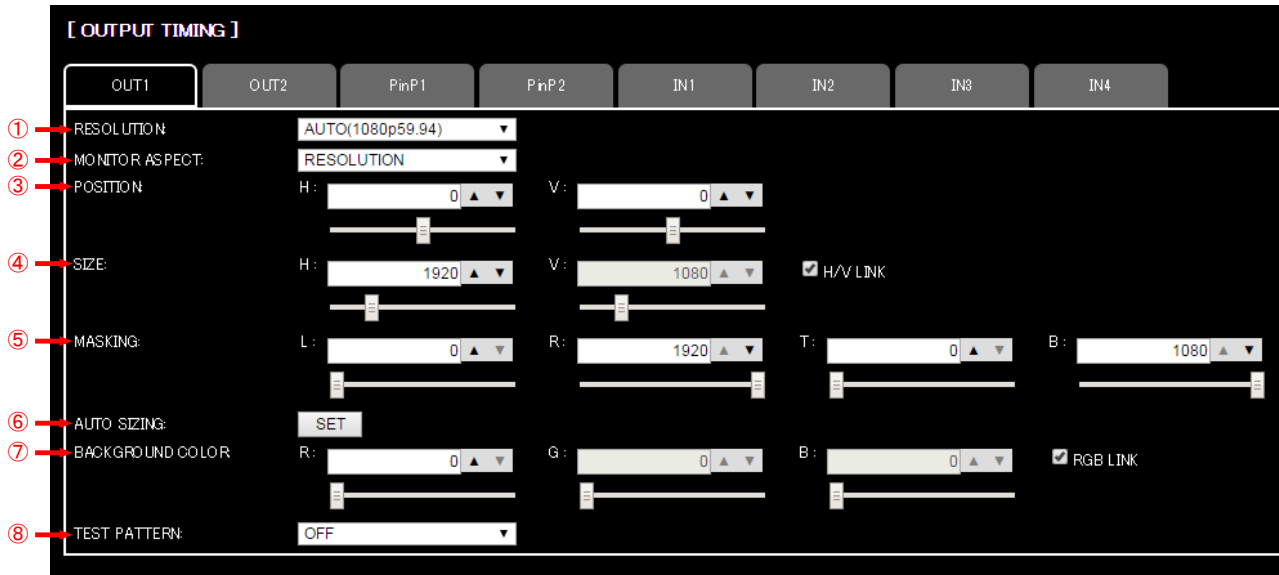

[Figure 8.7] Output timing page (output channel tab)

- ① 8.4.1 Output resolution (P.40)
- ② 8.4.2 Aspect ratio for sink device (P.41)
- ③ 8.4.6 Display position (P.43)
- ④ 8.4.7 Display size (P.43)
- ⑤ 8.4.8 Masking (P.44)
- ⑥ 8.4.9 Automatic sizing (P.45)
- ⑦ 8.4.10 Background color (P.45)
- ⑧ 8.4.11 Test pattern (P.45)

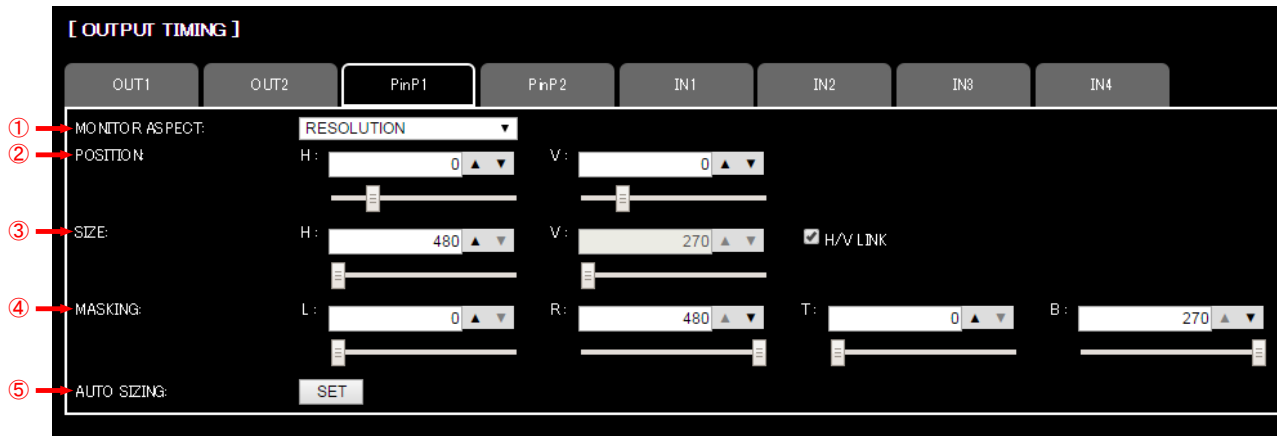

[Figure 8.8] Output timing page (PinP output tab)

- ① 8.4.2 Aspect ratio for sink device (P.41)
- ② 8.4.6 Display position (P.43)
- ③ 8.4.7 Display size (P.43)
- ④ 8.4.8 Masking (P.44)
- ⑤ 8.4.9 Automatic sizing (P.45)



[Figure 8.9] Output timing page (input channel tab)

- ① 8.4.3 Aspect ratio (P.41)
- ② 8.4.4 Aspect ratio control (P.42)
- ③ 8.4.5 Overscan (P.42)
- ④ 8.4.6 Display position (P.43)
- ⑤ 8.4.7 Display size (P.43)
- ⑥ 8.4.8 Masking (P.44)
- ⑦ 8.4.9 Automatic sizing (P.45)

## 8.4.1 Output resolution

---

Menu      OUTPUT TIMING → RESOLUTION

Setting for    Each output channel

Setting value

• AUTO	[Default]	• WXGA+	(1440x900)	• 720p 50Hz
• VGA	(640x480)	• WXGA++	(1600x900)	• 720p 59.94Hz
• SVGA	(800x600)	• UXGA	(1600x1200)	• 720p 60Hz
• XGA	(1024x768)	• WSXGA+	(1680x1050)	• 1080i 50Hz
• WXGA	(1280x768)	• VESAHD	(1920x1080)	• 1080i 59.94Hz
• WXGA	(1280x800)	• WUXGA	(1920x1200)	• 1080i 60Hz
• Quad-VGA	(1280x960)	• QWXGA	(2048x1152)	• 1080p 50Hz
• SXGA	(1280x1024)	• 480i 59.94Hz		• 1080p 59.94Hz
• WXGA	(1360x768)	• 480p 59.94Hz		• 1080p 60Hz
• WXGA	(1366x768)	• 576i 50Hz		
• SXGA+	(1400x1050)	• 576p 50Hz		

Normally, the optimal resolution will be selected automatically if you set this menu to “AUTO”.

Numbers following “@” are vertical synchronous frequency.

480i/480p/576i/576p/720p/1080i/1080p are the timings of CEA-861E standard.

Others are timings meeting VESA DMT standard or VESA CVT standard. VESAHD@60, WUXGA@60, and QWXGA@60 are output with Reduced Blanking.

### ■ “AUTO”

“AUTO”: selects the optimal resolution depending on the EDID of the connected sink device, and outputs video signal to the HDMI output connector. At this time, the resolution that is actually output is displayed in parentheses. In case EDID cannot be loaded from the sink device, the resolution that was used in the last time is selected with “\*” on its right side.

---

#### 【NOTE】

- If the MSD cannot read EDID from connected sink device, the MSD output resolution which is used last time. At this time, the dialog box is displayed to notice that the MSD cannot read EDID from sink device.
  - The output resolutions which the MSD support is limited as above list. If the sink device does not have any resolutions in the list, the MSD output most similar resolution. At this time, the dialog box is displayed to notice about this.
-



## 8.4.2 Aspect ratio for sink device

---

Menu OUTPUT TIMING → MONITOR ASPECT

Setting for Each output channel, each PinP output

Setting value

- RESOLUTION [Default]                      • 5:4                                      • 16:9
- 4:3    • 5:3                                      • 16:10

You can set the aspect ratio of the connected sink device.

If you select "RESOLUTION", the aspect ratio of the resolution selected in "**8.4.1 Output resolution (P.40)**" will be applied. If aspect ratio of the target sink device and the ratio set in "**8.4.1 Output resolution**" are different from each other, you can select an aspect ratio of the sink device from "4:3", "5:4", "5:3", "16:9", and "16:10".

## 8.4.3 Aspect ratio

---

Menu OUTPUT TIMING → ASPECT

Setting for Each input channel, each input signal

Setting value

- AUTO-1 [Default]                      • 14:9                                      • 14:9 SIDE PANEL
- AUTO-2    • 16:9 LETTER BOX                      • FULL
- 4:3    • 14:9 LETTER BOX                      • THROUGH
- 16:9    • 4:3 SIDE PANEL

You can set the aspect ratio of input video.

If you select "AUTO-1" or "AUTO-2", the aspect ratio will be restored automatically to the original ratio according to the settings of "**8.4.2 Aspect ratio for sink device (P.41)**" and "**8.4.4 Aspect ratio control (P.42)**". "AUTO-1" and "AUTO-2" work differently only when letter box signal is input. "AUTO-1" processes them as video signal of 16:9 or 14:9 while "AUTO-2" sets them as 4:3.

Normally, no problem occurs if you set the aspect ratio to "AUTO-1", but some DVD players and other devices display subtitles or setup menus on the area that does not have letter box signal video, which may not be displayed within the screen. In such case, set the aspect to "AUTO-2" to display the whole video.

Settings of "4:3", "16:9", "14:9", "16:9 / 14:9 LETTER BOX", and "4:3 / 14:9 SIDE PANEL" are enabled only when TV signal is input. When PC signal is input, the aspect ratio will be restored automatically according to the aspect of the input signal regardless of settings of "AUTO-1", "AUTO-2", "4:3", "16:9", "14:9", "16:9 / 14:9 LETTER BOX", and "4:3 / 14:9 SIDE PANEL".

"FULL": video signal is displayed always on full screen regardless of input video signal and settings of "**8.4.2 Aspect ratio for sink device**" and "**8.4.4 Aspect ratio control**".

"THROUGH": video signal is displayed always in pixel 1:1 regardless of settings of "**8.4.2 Aspect ratio for sink device**" and "**8.4.4 Aspect ratio control**".

### 8.4.4 Aspect ratio control

Menu OUTPUT TIMING→ASPECT PROCESS  
 Setting for Each input channel, each input signal  
 Setting value L-BOX/S-PANEL : letter box/side panel [Default]  
 S-CUT/TB-CUT : Side cut/top bottom cut

You can get how to restore aspect ratio.

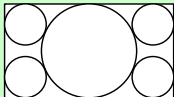
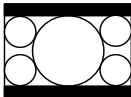
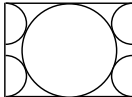
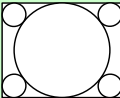
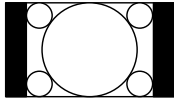
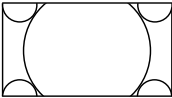
Input signal	Output signal	
	L-BOX/S-PANEL	S-CUT/TB-CUT
16:9 input video is output to a 4:3 sink device. 	Letter box 	Side cut 
4:3 input video is output to a 16:9 sink device. 	Side panel 	Top/bottom cut 

[Figure 8.10] Restoring aspect ratio

### 8.4.5 Overscan

Menu OUTPUT TIMING → OVER SCAN  
 Setting for Each input channel, each input signal  
 Setting value 100% to 115%  
 [Default] NTSC / PAL / SDTV: 105%; HDTV / PC: 100%

You can set enlarged display of input video.

## 8.4.6 Display position

---

Menu	OUTPUT TIMING → POSITION
Setting for	Input channel : each input channel, each input signal
	Output channel : each output channel
	PinP output : each PinP output

### Setting value

#### Input channel:

Horizontal position (-Horizontal input size to +Horizontal output resolution)	[Default] 0)
Vertical position (-Vertical input size to +Vertical output resolution)	[Default] 0)

#### Output channel:

Horizontal position (-Horizontal output size to +Horizontal output resolution)	[Default] 0)
Vertical position (-Vertical output size to +Vertical output resolution)	[Default] 0)

#### PinP output:

Horizontal position (-Horizontal output size to +Horizontal output resolution)	[Default] 0)
Vertical position (-Vertical output size to +Vertical output resolution)	[Default] 0)

You can set the position where input video is displayed.

---

**[NOTE]** If the resolutions of each output are not the same, the resolution of OUT1 will be the standard.

---

## 8.4.7 Display size

---

Menu	OUTPUT TIMING → SIZE
Setting for	Input channel : each input channel, each input signal
	Output channel : each output channel
	PinP output : each PinP output

### Setting value

#### Input channel:

Horizontal size (Horizontal output resolution ÷ 4 to Horizontal output resolution x 4)	[Default] Horizontal output resolution)
Vertical size (Vertical output resolution ÷ 4 to Vertical output resolution x 4)	[Default] Vertical output resolution)

#### Output channel:

Horizontal size (Horizontal output resolution ÷ 4 to Horizontal output resolution x 4)	[Default] Horizontal output resolution)
Vertical size (Vertical output resolution ÷ 4 to Vertical output resolution x 4)	[Default] Vertical output resolution)

#### PinP output:

Horizontal size (Horizontal output resolution ÷ 4 to Horizontal output resolution x 4)	[Default] Horizontal output resolution)
Vertical size (Vertical output resolution ÷ 4 to Vertical output resolution x 4)	[Default] Vertical output resolution)

You can set the display size of input video.

The video size is scaled based on the upper left of the input video set in "8.4.6 Display position (P.43)". If you set "LINK" to "ON", only settings of "H"(Horizontal) can be set and "V" is set automatically with the current aspect ratio kept.

---

**【NOTE】** If the resolutions of each output are not the same, the output resolution of OUT1 will be the standard.

---

## 8.4.8 Masking

Menu	OUTPUT TIMING → MASKING	
Setting for	Input channel	: each input channel, each input signal
	Output channe	: each output channel
	PinP output	: each PinP output
Setting value		
Input channel:	Left side masking	(Horizontal input position to Right side masking [Default] 0)
	Right side masking	(Left side masking to Horizontal input position+Horizontal input size [Default] Horizontal input size)
	Top side masking	(Vertical input position to Bottom side masking [Default] 0)
	Bottom side masking	(Top side masking to Vertical input position+Vertical input size [Default] Vertical input size)
Output channel:	Left side masking	(Horizontal output position (0 or more) to Right side masking [Default] 0)
	Right side masking	(Left side masking to Horizontal output position+Horizontal output size (Horizontal output resolution or less) [Default] Horizontal output resolution)
	Top side masking	(Vertical output position (0 or more) to Bottom side masking [Default] 0)
	Bottom side masking	(Top side masking to Vertical output position+Vertical output size (Vertical output resolution or less) [Default] Vertical output resolution)
PinP output:	Left side masking	(Horizontal output position (0 or more) to Right side masking [Default] 0)
	Right side masking	(Left side masking to Horizontal output position+Horizontal output size (Horizontal output resolution or less) [Default] Horizontal output resolution ÷ 4)
	Top side masking	(Vertical output position (0 or more) to Bottom side masking [Default] 0)
	Bottom side masking	(Top side masking to Vertical output position+Vertical output size (Vertical output resolution or less) [Default] Vertical output resolution ÷ 4)

You can set the masking of input video to hide unnecessary area (top/bottom and right/left).

---

**【NOTE】** If the resolutions of each output are not the same, the output resolution of OUT1 will be the standard.

---

## 8.4.9 Automatic sizing

Menu	OUTPUT TIMING → AUTO SIZING
Setting for	Input channel : each input channel, each input signal Output channel : each output channel PinP output : each PinP output

This function adjusts output signal optimally, and as a result, the following settings will be initialized automatically. Display size of PinP output is initialized as output resolution  $\div 4$  and displayed top left. By pressing "SET" button shows dialog box, and the initialization is executed by pressing "OK" button.

[Table 8.4] Items to be initialized

Items to be initialized	Input	Output	PinP
Aspect ratio, overscan	Initialized	-	-
Display position, display size, masking	Initialized	Initialized	Initialized

## 8.4.10 Background color

Menu	OUTPUT TIMING → BACKGROUND COLOR
Setting for	Each output channel
Setting value	R / G / B: 0 to 255 [Default]R / G / B: 0 (black)

## 8.4.11 Test pattern

Menu	OUTPUT TIMING → TEST PATTERN
Setting for	Each output channel
Setting value	[Figure 8.11] Test Pattern

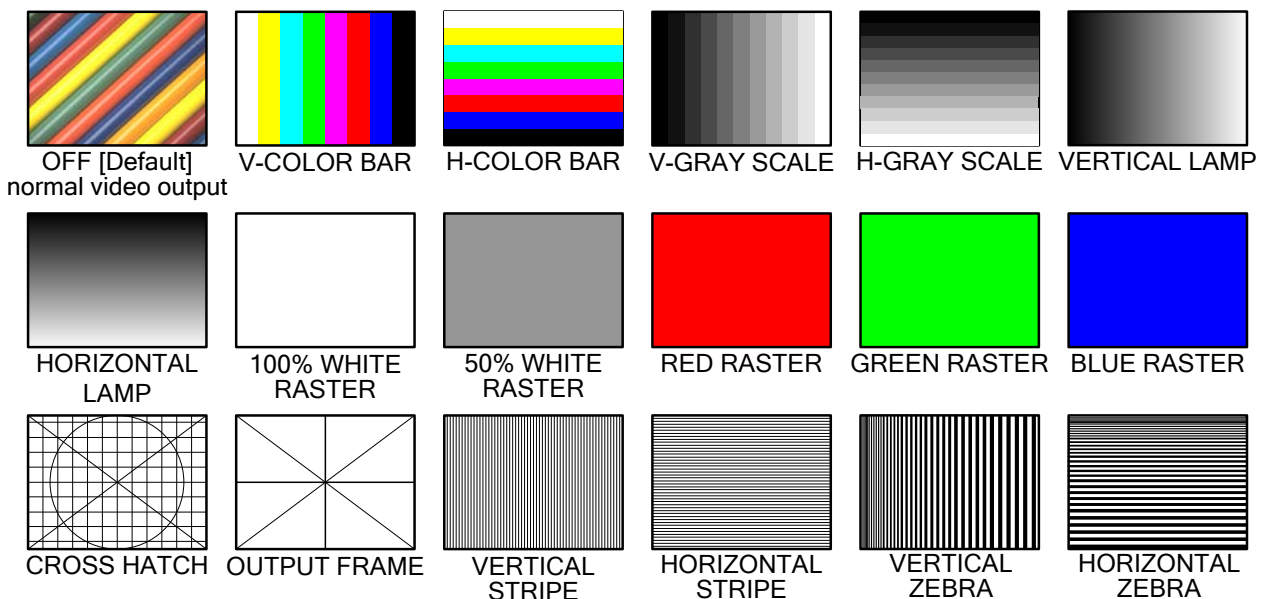

[Figure 8.11] Test Pattern

You can select a test pattern to be output instead of displaying video.

All settings of **"8.5 Quality settings (WEB menu) (P.47)"** will be invalid while a test pattern is displayed.

For "OUTPUT FRAME": use this pattern if edges are cut off due to enlargement display on the sink device.

Settings of **"8.4.6 Display position (P.43)"** and **"8.4.7 Display size (P.43)"** in the output side will be adjusted in order to display the test pattern on full screen.

For test patterns other than "OUTPUT FRAME": video is output on full screen with the resolution set in **"8.4.1 Output resolution (P.40)"** and the settings of **"8.4.6 Display position"**, **"8.4.7 Display size"**, **"8.4.8 Masking (P.44)"** will be invalid.

## 8.5 Quality settings (WEB menu)

Setting items for input channels are for correcting color bias.

Image quality to be output can be set for each input side (input channels) and output side (output channels) as follows.

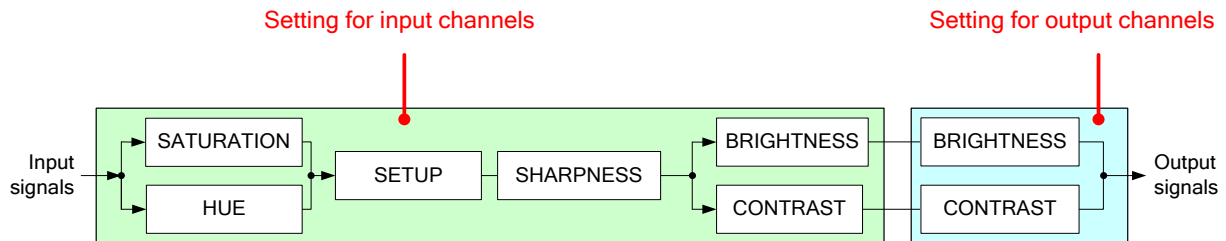

[Figure 8.12] Video correction

You can select channel which you want to set from each tab.

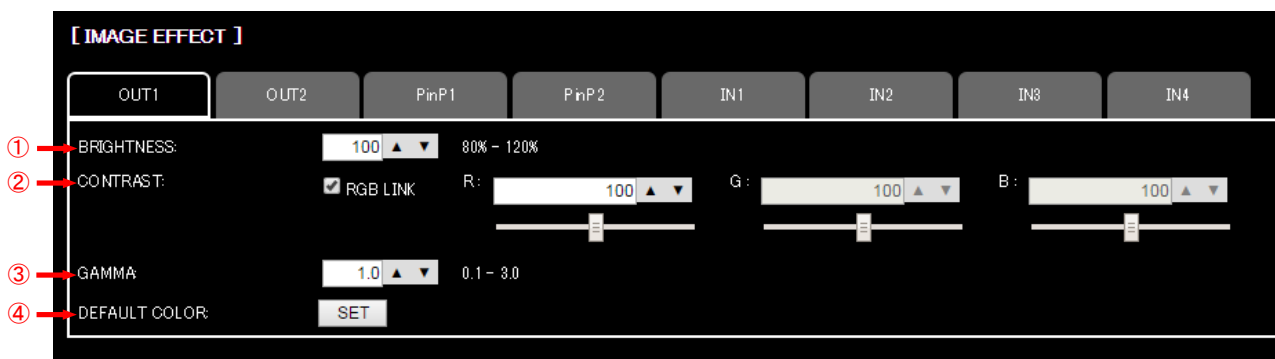

[Figure 8.13] Quality setting page (output channel and PinP output tab)

- ① 8.5.2 Brightness (P.49)
- ② 8.5.3 Contrast (P.49)
- ③ 8.5.7 Gamma (P.50)
- ④ 8.5.8 Default color (P.50)

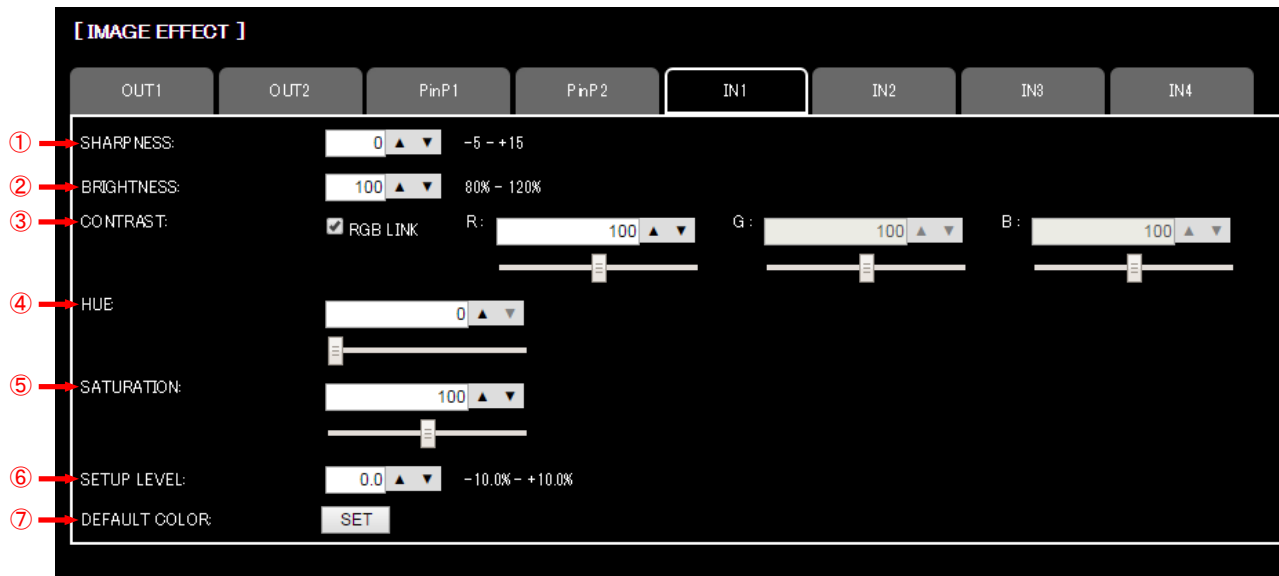

[Figure 8.14] Quality setting page (input channel tab)

- ① 8.5.1 Sharpness (P.49)
- ② 8.5.2 Brightness (P.49)
- ③ 8.5.3 Contrast (P.49)
- ④ 8.5.4 HUE (P.49)
- ⑤ 8.5.5 Saturation (P.50)
- ⑥ 8.5.6 Black level (P.50)
- ⑦ 8.5.8 Default color (P.50)



### 8.5.1 Sharpness

---

Menu	IMAGE EFFECT → SHARPNESS
Setting for	Each input channel, each input signal
Setting value	-5 to +15 [Default]:0

You can set the sharpness of video image..

### 8.5.2 Brightness

---

Menu	IMAGE EFFECT → BRIGHTNESS
Setting for	Input channel : each input channel, each input signal Output channel : each output channel PinP output : each PinP output
Setting value	80% to 120% [Default]:100%

You can set the brightness of video image..

### 8.5.3 Contrast

---

Menu	IMAGE EFFECT → CONTRAST
Setting for	Input channel : each input channel, each input signal Output channel : each output channel PinP output : each PinP output
Setting value	R / G / B : 0% to 200% [Default]:R / G / B: 100%

You can set the contrast of video image.

If you check "RGB LINK" check box, only settings of "R" can be set, and "G" and "B" change relatively.

### 8.5.4 HUE

---

Menu	IMAGE EFFECT → HUE
Setting for	Each input channel, each input signal
Setting value	0° to 359° [Default]: 0°

You can set HUE of input signal.

## 8.5.5 Saturation

---

Menu  IMAGE EFFECT → SATURATION  
 Setting for  Each input channel, each input signal  
 Setting value  0% to 200% [Default]: 100%

You can set the saturation of input signal.

## 8.5.6 Black level

---

Menu  IMAGE EFFECT → SETUP LEVEL  
 Setting for  Each input channel, each input signal  
 Setting value  -10.0% to +10.0% (by 0.5%) [Default]: ±0.0%

You can adjust the black level of input signal.

---

**【NOTE】** If you type the value directly into text area, you must type decimal digit aslo.

---

## 8.5.7 Gamma

---

Menu  IMAGE EFFECT → GAMMA  
 Setting for  Each output channel, each PinP output  
 Setting value  0.1 to 3.0 (0.1 steps) [Default]: 1.0

You can adjust the gamma of output signal.

---

**【NOTE】** If you type the value directly into text area, you must type decimal digit aslo.

---

## 8.5.8 Default color

---

Menu  IMAGE EFFECT → DEFAULT COLOR  
 Setting for  Input channel : each input channel, each input signal  
                    Output channe : each output channel  
                    PinP output : each PinP output

You can initialize settings of the following items.

By pressing "SET" button shows dialog box, and the initialization is executed by pressing "OK" button.

**[Table 8.5] Items to be initialized**

Items to be initialized	Input	Output	PinP
Brightness, contrast	Initialized	Initialized	Initialized
Sharpness, hue, saturation, black level	Initialized	-	-
Gamma	-	Initialized	Initialized

## 8.6 Input settings (WEB menu)

You can set input settings from this page. Setting conditions are different between top side of the center line and bottom side of the center line. Settings on top side of the center line can select channel from tabs, and settings on bottom side of the center line are common setting items for all channels.

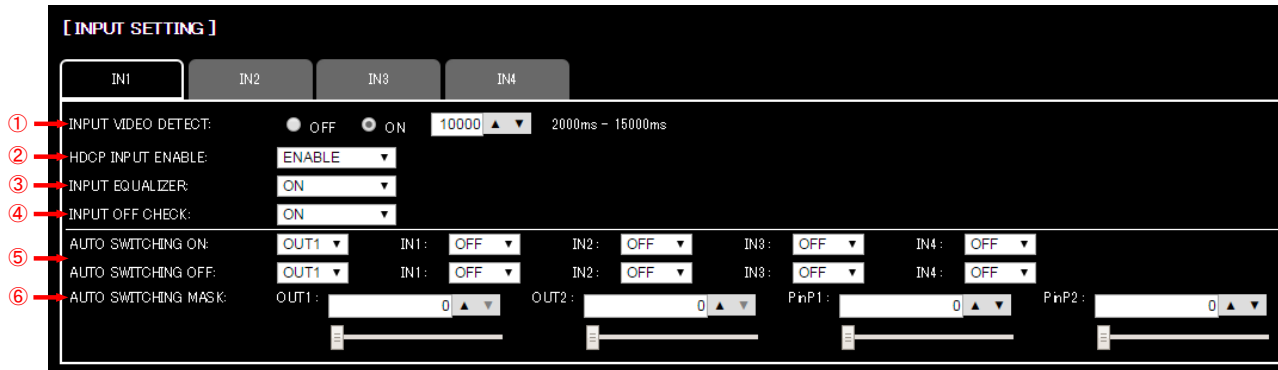

[Figure 8.15] Input setting page

- ① 8.6.1 No-signal input monitoring (P.52)
- ② 8.6.2 Setting HDCP input (P.52)
- ③ 8.6.3 Input equalizer (P.53)
- ④ 8.6.4 Automatic detection of input video interruption (P.53)
- ⑤ 8.6.5 Priority of input channel automatic switching (P.54)
- ⑥ 8.6.6 Masking time after automatic switching of input channel (P.55)

## 8.6.1 No-signal input monitoring

Menu	INPUT SETTING → INPUT VIDEO DETECT
Setting for	Each input channel
Setting value	OFF, 2000ms to 15000ms (100 ms steps) [Default]: 10000ms

If you change the settings of EDID of the MSD or turn off/on the MSD, the source device may not output video signal. Use this menu to set the monitoring time which is from when a source device stops outputting signal to when the MSD requests the source device to output video signal.

### 【NOTE】

If you use the monitor power-saving function or Dual monitor function of the PC, set this menu to “OFF”. The PC that receives output request may cancel those functions.

If you set shorter time than the time which the source device outputs video, the source device may not output video. In such case, set the longer time.

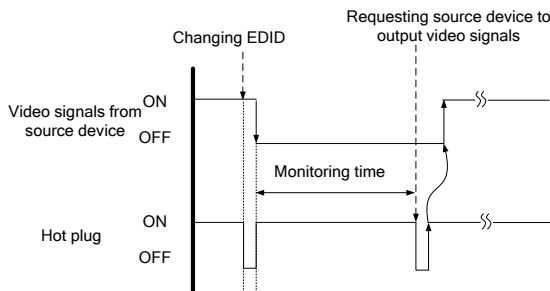

[Figure 8.16] Monitoring absence of input

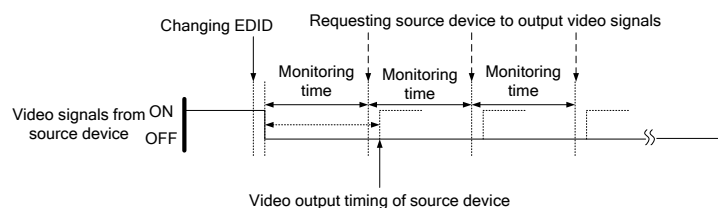

[Figure 8.17] Repeating reset

## 8.6.2 Setting HDCP input

Menu	INPUT SETTING → HDCP INPUT ENABLE
Setting for	Each input channel
Setting value	ENABLE [Default], DISABLE

Some source devices check whether the connected device supports HDCP and then determine whether they encrypt HDCP signal or not. Since the MSD is HDCP compliant, if it is connected to a sink device that is not HDCP compliant, the sink device may not display video.

You can set whether the MSD encrypts HDCP to the source device. “ENABLE” is set by default, but if you want to connect the MSD to a sink device that is not HDCP compliant, select “DISABLE” to disable the encryption of HDCP output from the source device.

### 8.6.3 Input equalizer

---

Menu	INPUT SETTING → INPUT EQUALIZER
Setting for	Each input channel (only for HDMI connector)
Setting value	ON [Default], OFF

HDMI input connector has an equalizer circuit to correct attenuated signal caused when a long cable is connected. If you set this menu to "ON", signal is corrected automatically according to the amount of the attenuation. However, if you connect a cable booster or the like for input of the MSD, compensatory functions may sometimes conflict and signal cannot be corrected appropriately. In such a case, set this menu to "OFF".

### 8.6.4 Automatic detection of input video interruption

---

Menu	INPUT SETTING → INPUT OFF CHECK
Setting for	Each input channel
Setting value	ON [Default], OFF

The MSD can stop outputting video immediately after input video signal is disconnected for a moment. Use this function to reduce distorted output video occurred at the time of switching if an external switcher is connected for input of the MSD. The processing of this function is the same as that of switching input.

- **8.8.4 Window transition effect (P.61)**
- **8.8.5 Window transition speed (P.61)**
- **8.8.6 Wipe color (P.62)**

---

#### 【NOTE】

If you select "ON" and input video (VHS tapes or the like) that has a bad record condition, outputting video will be ON/OFF repeatedly due to distorted synchronous idles. In this case, set this menu to "OFF".

Even if you set this item to "ON", distorted video cannot be corrected completely when input video signal is lost. Especially if you set "**8.8.4 Window transition effect**" to an option other than "CUT", noises or black bars may be output at the time of fading out or wiping out.

---

### 8.6.5 Priority of input channel automatic switching

Menu INPUT SETTING → AUTO SWITCHING ON / AUTO SWITCHING OFF  
 Setting for Each input channel, each output channel, each PinP output  
 Setting value [Table 8.6] Setting of priority of input channel automatic switching

[Table 8.6] Setting of priority of input channel automatic switching

Item	Set value	Default
Output channel	OUT1, OUT2, PinP1, PinP2	OUT1
Priority of each input channel (IN1 to IN4)	1 (high) to 4 (low), OFF	OFF

■ **AUTO SWITCHING ON**

AUTO SWITCHING ON menu switches input signal when the input signal changes from “OFF” to “ON”. The MSD switches input signals automatically based on following conditions;

- When the input signal become from “OFF” to “ON”, and that input channel has higher priority that current channel or same priority level.
- When the input signal become from “OFF” to “ON”, and other input channels, that have higher priority than the input signal, do not have input signal.

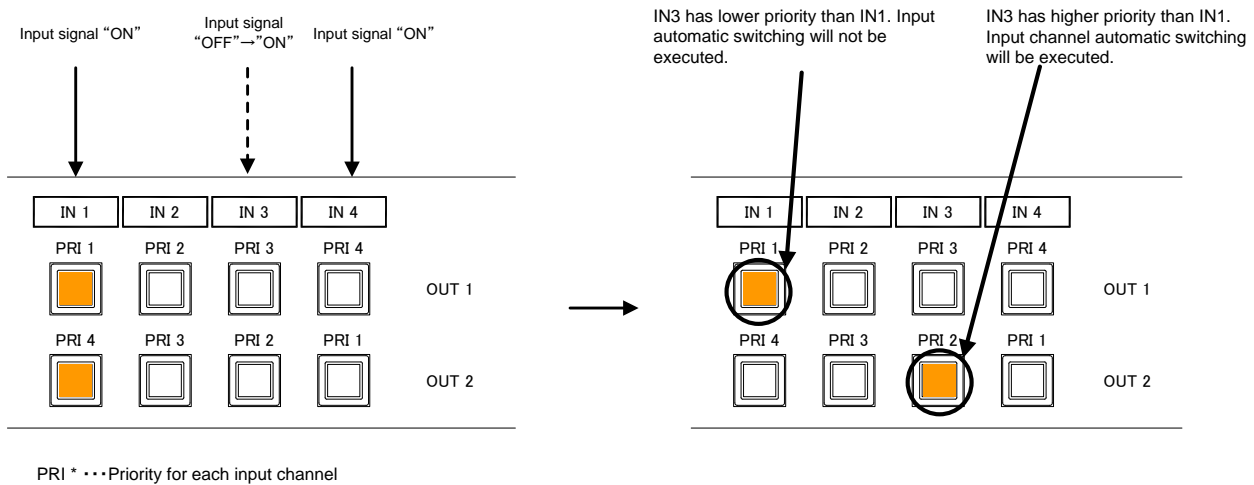

[Figure 8.18] Input channel automatic switching “OFF” to “ON”

## ■ AUTO SWITCHING OFF

AUTO SWITCHING OFF menu switches input signal when the input signal changes from "ON" to "OFF". The MSD switches input signals automatically based on following conditions;

- When the input signal become from "ON" to "OFF" and there are any input signals on other input channels, and that input channel has higher priority that current channel or same priority level.
- When there are input channels which have same priority more than one, the input channel is switched to the the input channel which has signal and less input channel number.

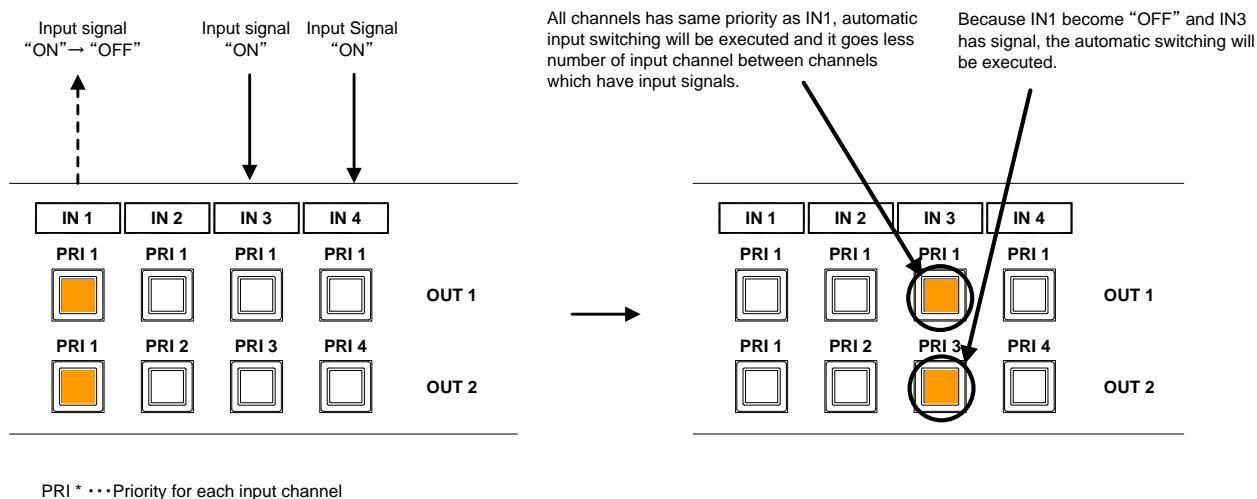

**[Figure 8.19] Input channel automatic switching "ON" to "OFF"**

If the priority setting of the input channel is "OFF", input channel automatic switching is not executed.

### 8.6.6 Masking time after automatic switching of input channel

Menu	INPUT SETTING → AUTO SWITCHING MASK
Setting for	Each output channel, each PinP output
Setting value	0s000ms to 999s999ms [Default: 0s000 ms]

Set the channels switching mode when auto switching is executed. When the input channel is switched automatically, this setting has priority regardless channel switching mode which is selected from front panel.

【See: 8.6.5 Priority of input channel automatic switching (P.54)】

## 8.7 Input timing (WEB menu)

You can set input timing of analog input video if signal is input.

Since the MSD loads the optimal table from the built-in tables and adjusts the input timing automatically, you do not need to set this menu. However, if signal which are not registered in the MSD tables are input or if part of the output video is cut off by using the standard table registered in the MSD, set the input timing manually. You can select channel which you want to set from each tab. If you select tab which does not have input signal, a dialog box show up and you cannot set up.

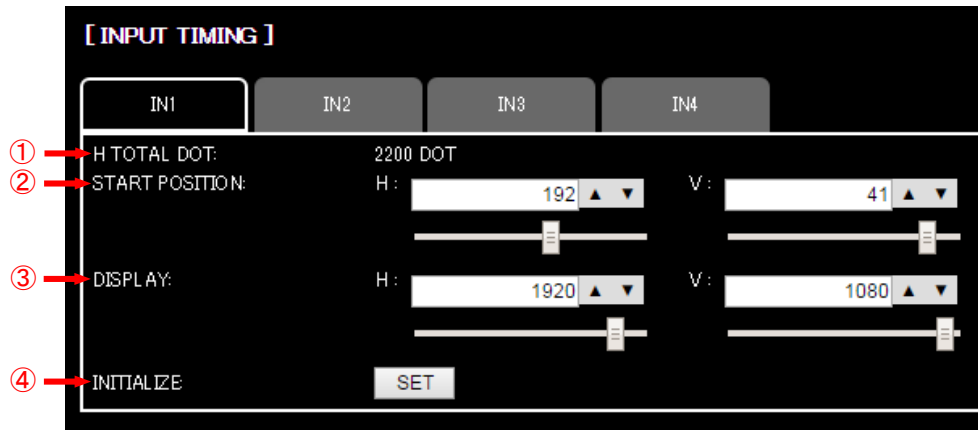

[Figure 8.20] Input timing page

- ① 8.7.1 The total number of horizontal dots (P.57)
- ② 8.7.2 Start position (P.57)
- ③ 8.7.3 Active area (P.58)
- ④ 8.7.4 Input timing initialization (P.58)



## 8.7.1 The total number of horizontal dots

---

Menu	INPUT TIMING → H TOTAL DOTS
Setting for	Each input channel, each input signal
Setting value	400DOT to 4125DOT [Default] varies depending on the input signal.

You can confirm the total number of horizontal dots. This menu cannot be set.

If there is no input signal notice will be shown instead of the total number of horizontal dots information.

## 8.7.2 Start position

---

Menu	INPUT TIMING → START POSITION
Setting for	Each input channel, each input signal
Setting value	[Table 8.7] Settings of strat position

[Table 8.7] Settings of strat position

Function	Setting value
Horizontal start position	64DOT to 2900DOT (The total number of horizontal dots—Horizontal active area or less)
Vertical start position	10LINE to 2048LINE (The total number of vertical lines—Vertical active area or less)

[Default] varies depending on the input signal.

You can set the horizontal/vertical starting position.

Setting value must be as follows. If the set value exceeds the value, the starting position will be set the limit value within the settable range automatically.

Horizontal : The total number of horizontal dots > Horizontal active area > Horizontal starting position

Vertical : The total number of vertical lines > Vertical active area > Vertical starting position

You can set the horizontal/vertical starting position if there is no input signal..

### 8.7.3 Active area

---

Menu INPUT TIMING → DISPLAY  
 Setting for Each input channel, each input signal  
 Setting value **[Table 8.8] Settings of active area**

**[Table 8.8] Settings of active area**

Function	Setting value
Horizontal active area	64DOT to 2900DOT (The total number of horizontal dots—64 or less)
Vertical active area	10LINE to 2048LINE (The total number of vertical lines—10 or less)

[Default] varies depending on the input signal.

You can set the horizontal/vertical active area of input video.

You cannot set the horizontal/vertical active area of input video if there is no input signal.

### 8.7.4 Input timing initialization

---

Menu INPUT TIMING → INITIALIZE  
 Setting for Each input channel, each input signal

You can initialize input timing settings.

By pressing "SET" button shows dialog box, and the initialization is executed by pressing "OK" button.

You cannot initialize input timing setting if there is no input signal.

## 8.8 Output settings (WEB menu)

You can set output settings from this page.

You can select channel which you want to set from each tab.

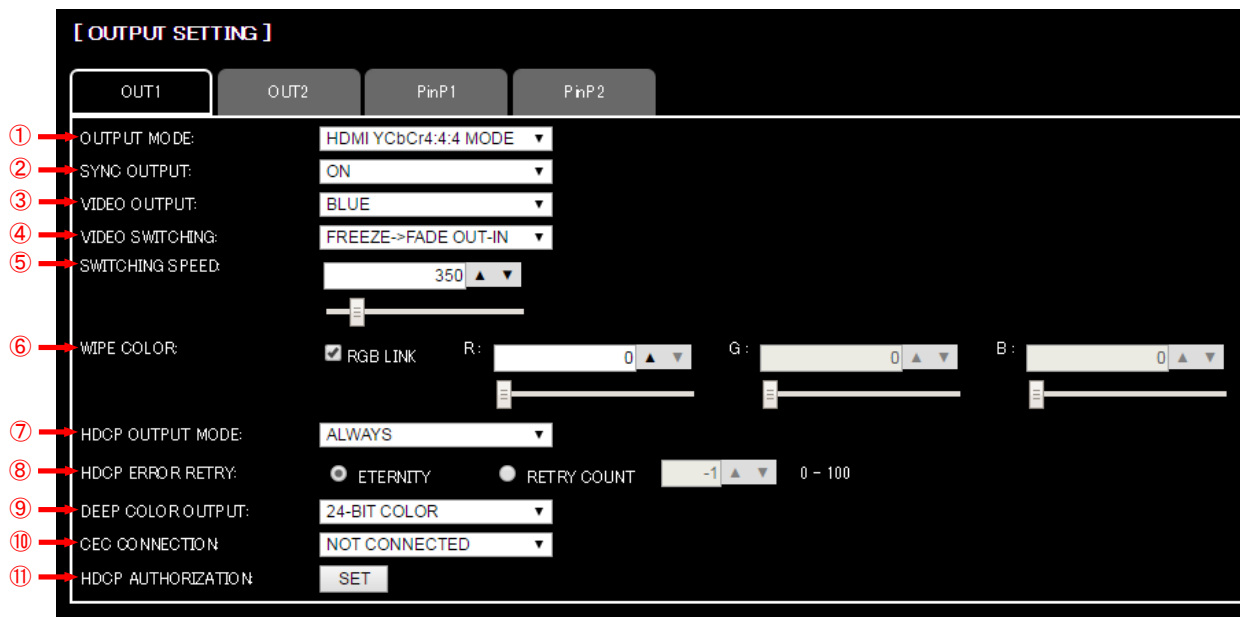

[Figure 8.21] Output setting (output channel tab)

- ① 8.8.1 Output mode (P.60)
- ② 8.8.2 Synchronous signal output with no input video (P.60)
- ③ 8.8.3 Output video with no input video (P.61)
- ④ 8.8.4 Window transition effect (P.61)
- ⑤ 8.8.5 Window transition speed (P.61)
- ⑥ 8.8.6 Wipe color (P.62)
- ⑦ 8.8.7 HDCP output (P.62)
- ⑧ 8.8.8 The number of HDCP retries (P.62)
- ⑨ 8.8.9 Deep Color (P.63)
- ⑩ 8.8.10 CEC connection (P.63)
- ⑪ 8.8.11 HDCP re-authentication (P.63)

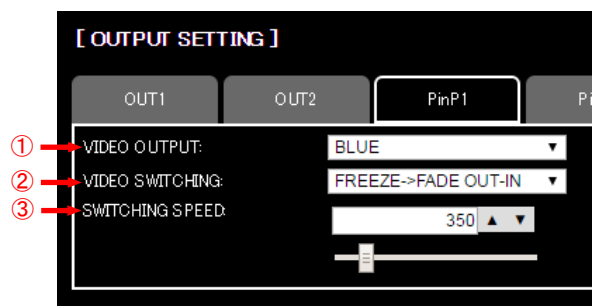

[Figure 8.22] Output setting (PinP output tab)

- ① 8.8.3 Output video with no input video (P.61)
- ② 8.8.4 Window transition effect (P.61)
- ③ 8.8.5 Window transition speed (P.61)

## 8.8.1 Output mode

Menu OUTPUT SETTING → OUTPUT MODE

Setting for Each output channel

Setting value

- DVI MODE
- HDMI YCbCr4:2:2 MODE
- HDMI RGB MODE
- HDMI YCbCr4:4:4 MODE [Default]

You can select an output mode.

Set the mode to "HDMI YCbCr4:4:4 MODE" to output video with the optimal mode automatically even if a sink device that does not support HDMI component signal or DVI signal is connected. If you want to output video with HDMI RGB signal or DVI signal forcibly, set the desired mode.

The MSD checks signal types in order of the table below and output signal with the first matched signal type.

[Table 8.9] Output mode priority

Output mode	Signal supported by sink device			
	DVI	HDMI RGB	HDMI YCbCr4:2:2	HDMI YCbCr4:4:4
DVI MODE	1st	-	-	-
HDMI RGB MODE	2nd	1st	-	-
HDMI YCbCr4:2:2 MODE	3rd	2nd	1st	-
HDMI YCbCr4:4:4 MODE	4th	3th	2nd	1st

### 【NOTE】

If you set "DVI MODE", digital audio cannot be output. "HDMI YCbCr4:4:4 MODE" and "HDMI YCbCr4:2:2 MODE" are only output when the resolution is AV resolution (480i, 576i, 720p, 1080i, 1080p), and PC resolutions are output "HDMI RGB MODE" or "DVI MODE".

## 8.8.2 Synchronous signal output with no input video

Menu OUTPUT SETTING → SYNC OUTPUT

Setting for Each output channel

Setting value ON [Default], OFF

You can set whether synchronous signal is output when no video signal is input from the selected input, or when "OFF" is selected for the input. If you set this menu to "ON", you can prevent the sink device from being switched to the standby mode.

### 【NOTE】

When PinP output turns "ON" from "OFF", the MSD does not output synchronize signal only if all input channels become no signal.

### 8.8.3 Output video with no input video

---

Menu	OUTPUT SETTING → VIDEO OUTPUT		
Setting for	Each output channel, each PinP output		
Setting value	· BLUE [Default]	· BACKGROUND COLOR	· BLACK

You can set the color of the video to be output when no video signal is input from the selected input. The setting will be valid when “**8.8.2 Synchronous signal output with no input video (P.60)**” is set to “ON”.

---

**[NOTE]** PinP output cannot set “BACKGROUND COLOR”

---

### 8.8.4 Window transition effect

---

Menu	OUTPUT SETTING → VIDEO SWITCHING		
Setting for	Each output channel, each PinP output		
Setting value	· CUT	· LEFT→RIGHT WIPE	· TOP→BOTTOM WIPE
	· FADE OUT-IN	· RIGHT→LEFT WIPE	· BOTTOM→TOP WIPE
	· FREEZE→FADE OUT-IN [Default]		

You can select a window transition effect for when the video inputs is switched.

The setting will be valid also when “**8.6.4 Automatic detection of input video interruption (P.53)**” is set to “ON”.

---

**[NOTE]** For PinP output, “LEFT→RIGHT WIPE”, “RIGHT→LEFT WIPE”, “TOP→BOTTOM WIPE” and “BOTTOM→TOP WIPE” cannot be set.

---

### 8.8.5 Window transition speed

---

Menu	OUTPUT SETTING → SWITCHING SPEED
Setting for	Each output channel, each PinP output
Setting value	100ms to 2000ms (per 10 ms.) [Default]: 350 ms.

You can set the window transition speed for FADE OUT/IN or WIPE OUT/IN when the input channel is switched.

The setting will be valid also when “**8.6.4 Automatic detection of input video interruption (P.53)**” is set to “ON”.

## 8.8.6 Wipe color

---

Menu	OUTPUT SETTING → WIPE COLOR
Setting for	Each output channel
Setting value	R / G / B: 0 to 255 [Default]: R / G / B: 0 (black)

You can set the wipe color while switching video input when the input channel is switched. If you check "RGB LINK" check box, only settings of "R" can be set, and "G" and "B" change relatively.

## 8.8.7 HDCP output

---

Menu	OUTPUT SETTING → HDCP OUTPUT MODE
Setting for	Each output channel
Setting value	ALWAYS : HDCP is output at all time. [Default]
	DISABLE : HDCP is not authorized (only video and audio without HDCP are output)
	HDCP INPUT ONLY : HDCP is output only if input signal has HDCP.

You can set the HDCP output for when a sink device supporting HDCP is connected. Normally set this menu to "ALWAYS". The MSD output signal with HDCP always.

If you select "DISABLE", the MSD never conducts HDCP authentication. Only the input signal which does not have HDCP can be output.

If you select "HDCP INPUT ONLY", the MSD conducts HDCP authentication only if the input signal has HDCP. However, if input channel is changed to others and HDCP authentication status is changed, the MSD starts HDCP authentication again. This action may take time to output video and audio.

If the sink device which does not support HDCP is connected, the MSD can output only the video and audio which do not have HDCP regardless this menu.

## 8.8.8 The number of HDCP retries

---

Menu	OUTPUT SETTING → HDCP ERROR RETRY
Setting for	Each output channel
Setting value	ETERNITY : retry until succeeded [Default], 0 to 100 : 0 to 100 times

You can set the number of HDCP retries.

If a sink device with HDCP is connected and you set "**8.8.7 HDCP output (P.62)**" to "ALWAYS" or "HDCP INPUT ONLY", HDCP is authorized regardless of the status of input signal. Normally, set this menu to "ETERNITY" to retry the authentication automatically after the first authentication fails. However, you can set the number of retries manually. (If retry is not succeeded even after the MSD retries for the set number of retry times, video and audio with HDCP are not output.)

### 8.8.9 Deep Color

---

Menu      OUTPUT SETTING → DEEP COLOR OUTPUT

Setting for    Each output channel

Setting value   24-BIT COLOR [Default], 30-BIT COLOR

You can select the color depth of HDMI signal.

“30-BIT COLOR”: signal is output with “30-BIT COLOR” only if a sink device supporting Deep Color is connected. If a sink device that does not support Deep Color is connected, signal is output with “24-BIT COLOR” automatically. However, since the transmission clock of “30-BIT COLOR” is faster than that of “24-BIT COLOR”, noise may occur if a bad-quality cable or long cable is connected. In those cases, the noise may be removed by selecting “24-BIT COLOR”.

### 8.8.10 CEC connection

---

Menu      OUTPUT SETTING → CEC CONNECTION

Setting for    Each output channel

Setting value

- NOT CONNECTED [Default]
- SELECTED CHANNEL
- IN1 to IN4

You can set which I/O to be connected when a device supporting CEC is connected.

---

#### 【NOTE】

- Using CEC may cause negative effects. If you do not use CEC, set this menu to “NOT CONNECTED.” If the status of the sink devices connected to the HDMI output connector changes (such as being turned OFF→ON) or if the CEC connection changes, the EDID may also need to be changed (the MSD changes it automatically) in order to update the address of the connected device. When the EDID is changed, the source device stops outputting video temporarily. Note the following points to not make the EDID change at the time of operation.
  - CEC connection is a one-on-one basis; it cannot connect multiple inputs and outputs. If you set multiple outputs to connect to the same input, only a smaller output number is connected preferentially and other outputs are not connected.
- 

### 8.8.11 HDCP re-authentication

---

Menu      OUTPUT SETTING → HDCP AUTHENTICATION

Setting for    Each output channel

If a sink device supporting HDCP is connected, HDCP is authorized automatically. You can re-authorize HDCP manually using this menu (connection Reset is performed automatically, but it can be performed manually using this menu). By pressing “SET” button shows dialog box, and the HDCP re-authentication is executed by pressing “OK” button.

## 8.9 Audio settings (WEB menu)

HDMI digital audio supports the following formats. Set audio in response to devices connected to the HDMI and HDBaseT output connectors. Only “2 channel linear PCM” can be input by factory default. If you want to use “Multi channel linear PCM” or bit stream signal (compressed audio), set “Audio format” and “Speaker configuration”.

【See: 8.10.5 Audio format (P.73)】

【See: 8.10.6 Speaker configuration (P.74)】

[Table 8.10] Audio format

Audio format	Description
2 channel linear PCM	2ch,32 kHz to 192 kHz,16 / 20 / 24 bit
Multi channel linear PCM	8ch,32 kHz to 192 kHz,16 / 20 / 24 bit
AC-3, Dolby Digital, DTS, Dolby Digital+, DTS-HD, Dolby TrueHD, AAC	Bit stream

■ **If multi channel linear PCM signal input to digital audio:**

If Multi channel linear PCM signal are input to digital audio, two channels set in “8.9.4 Multi channel audio output (P.67)” or down-mixed audio is output to analog audio and sink devices that do not support multi linear PCM.

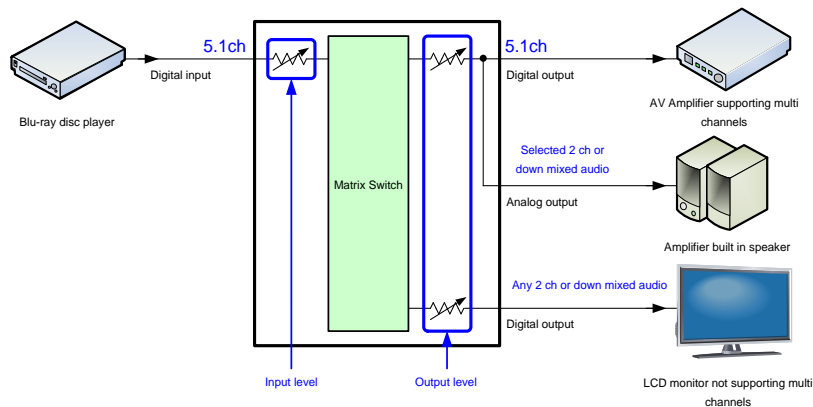

[Figure 8.23] Multi channel linear PCM input

■ **If bit stream signal input to digital audio:**

If bit stream signal (compressed audio) such as Dolby Digital is input to HDMI digital audio, these input audio signal is output to digital audio as they are. They are not output to analog audio, and audio volume cannot be adjusted.

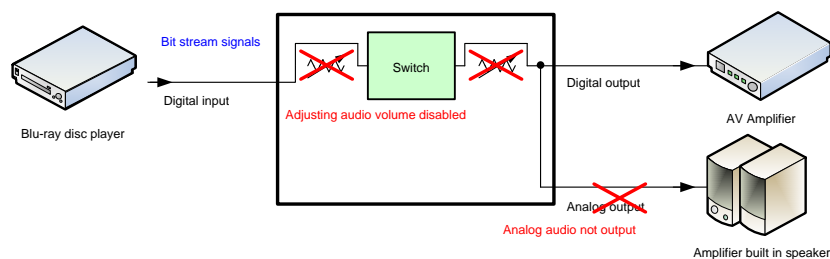

[Figure 8.24] Inputting/Outputting bit stream signal



You can set audio input and output settings from this page.

Setting conditions are different between top side of the center line and bottom side of the center line. Settings on top side of the center line can select channel from tabs, and settings on bottom side of the center line are common setting items for all channels.

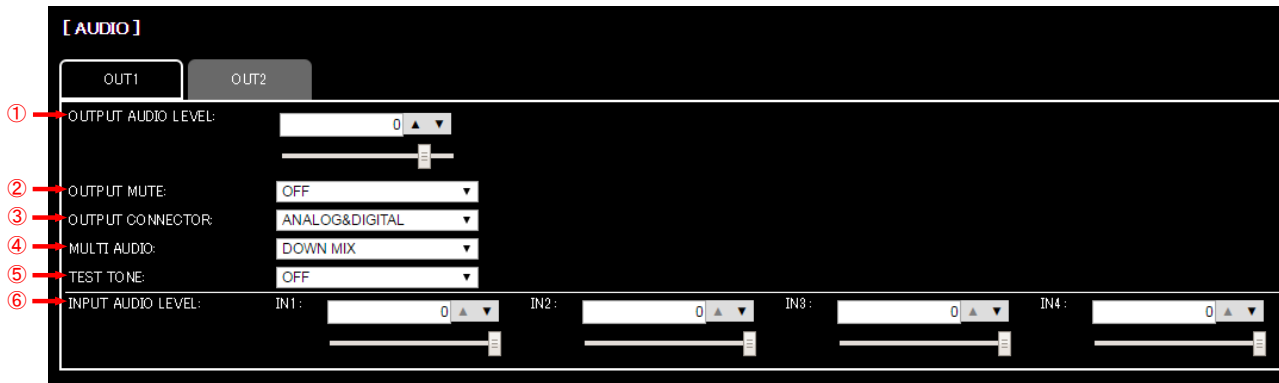

[Figure 8.25] Audio setting

- ① 8.9.1 Output level (P.66)
- ② 8.9.2 Output mute (P.66)
- ③ 8.9.3 Audio output connector (P.66)
- ④ 8.9.4 Multi channel audio output (P.67)
- ⑤ 8.9.5 Test tone (P.67)
- ⑥ 8.9.6 Input level (P.67)

## 8.9.1 Output level

---

Menu AUDIO → OUTPUT LEVEL  
 Setting for Each output channel  
 Setting value -60dB to +10dB [Default] ±0dB

You can set the audio output level.

If you change the output level while audio output mute is set to "ON", mute is canceled.

## 8.9.2 Output mute

---

Menu AUDIO → OUTPUT MUTE  
 Setting for Each output channel  
 Setting value OFF [Default], ON

You can enable or disable the audio output mute.

## 8.9.3 Audio output connector

---

Menu AUDIO → OUTPUT CONNECTOR  
 Setting for Each output channel  
 Setting value **[Table 8.11] Settings of audio output control**

You can set audio output signal from audio output connector and HDMI and HDBaseT output connectors.

**[Table 8.11] Settings of audio output control**

Setting value	Analog audio output connector	HDMI output connector	HDBaseT output connector
ANALOG&DIGITAL [Default]	Can be output	Can be output	Can be output
ANALOG	Can be output	Cannot be output	Cannot be output
DIGITAL	Cannot be output	Can be output	Can be output

## 8.9.4 Multi channel audio output

---

Menu AUDIO → MULTI AUDIO

Setting for Each output channel

Setting value

- DOWN MIX [Default]
- CH1/CH2 STEREO      • CH7/CH8 STEREO    • CH5/CH6 MONO
- CH3/CH4 STEREO      • CH1/CH2 MONO      • CH7/CH8 MONO
- CH5/CH6 STEREO      • CH3/CH4 MONO

You can set audio to be output to a sink device that does not support multi-channel linear PCM or analog audio for when multi-channel linear PCM audio is input from an HDMI input connector.

You can select audio from “DOWN MIX” (multi-channel audio is downmixed), stereo audio, and monaural audio.

## 8.9.5 Test tone

---

Menu AUDIO → TEST TONE

Setting for Each output channel

Setting value

- OFF [Default]
- ALL                      • LOW FREQUENCY EFFECT
- FRONT L/R              • FRONT CENTER
- REAR L/R                • REAR LEFT
- REAR L/R CENTER      • REAR RIGHT
- FRONT LEFT             • REAR LEFT CENTER
- FRONT RIGHT            • REAR RIGHT CENTER

You can output 1 kHz test tone.

Since test tone can be output only to specific speakers, you can check the position of the speakers.

For “LOW FREQUENCY EFFECT”, only test tone of 30 Hz is output.

## 8.9.6 Input level

---

Menu AUDIO → INPUT AUDIO LEVEL

Setting for Each input channel, each input signal

Setting value -60dB to  $\pm 0$ dB [Default]:  $\pm 0$ dB

You can correct the gap in audio input levels of each input signal, because audio input level can be set for each input connector.

## 8.10 EDID: Extended Display Identification Data (WEB menu)

You can set or customize EDID to be sent to the source device. Change the setting as needed.

### ■ Setting EDID

- (1) If you use copied EDID, copy the target EDID from the sink device.
- (2) Set the EDID that will be sent to the source device.
- (3) If you use built-in EDID, customize the data as usage.

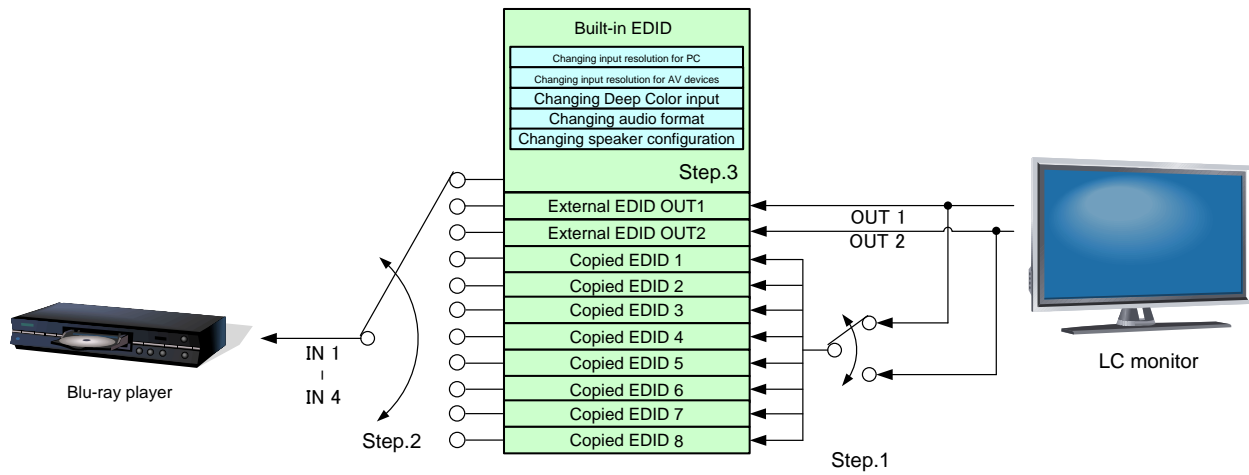

[Figure 8.26] Setting EDID

You can set EDID settings from this page.

Setting conditions are different between top side of the center line and bottom side of the center line. Settings on top side of the center line can select channel from tabs, and settings on bottom side of the center line are common setting items for all channels.

[Figure 8.27] EDID

- ① 8.10.1 EDID (P.70)
- ② 8.10.2 Resolution for PCs (P.71)
- ③ 8.10.3 Input resolution for AV devices (P.72)
- ④ 8.10.4 Deep Color (P.73)
- ⑤ 8.10.5 Audio format (P.73)
- ⑥ 8.10.6 Speaker configuration (P.74)
- ⑦ 8.10.7 Copying EDID (P.75)

## 8.10.1 EDID

---

Menu EDID → EDID DATA

Setting for Each input channel

Setting value

- INTERNAL EDID [Default]
- OUT1 MONITOR
- COPY DATA1 to COPY DATA8
- OUT2 MONITOR

You can set the EDID to be sent to the source device from built-in EDID ("INTERNAL EDID"), connected sink device's EDID ("MONITOR") and copied EDID ("COPY DATA"). EDID copied from a sink device will be displayed if any.

By pressing "SET" button shows dialog box, and EDID setting is renewed by pressing "OK" button.

**【See: 8.10.7 Copying EDID (P.75) 】**

## 8.10.2 Resolution for PCs

Menu EDID → PC RESOLUTION

Setting for Each input channel

Setting value

- SVGA(800x600)      • Quad-VGA(1280x960)      • WXGA+(1440x900)      • 1080p(1920x1080)
  - XGA(1024x768)      • SXGA(1280x1024)      • WXGA++(1600x900)      • WUXGA(1920x1200)
  - 720p(1280x720)      • WXGA(1360x768)      • UXGA(1600x1200)      • QWXGA(2048x1152)
  - WXGA(1280x768)      • WXGA(1366x768)      • WSXGA+(1680x1050)
  - WXGA(1280x800)      • SXGA+(1400x1050)      • 1080i(1920x1080)
- [Default] 1080p(1920x1080)

You can set the resolution requested to be output from source devices.

This setting will also be applied for controlling output resolution when AV devices (such as Blu-ray players) are connected via HDMI. For digital input, only "INTERNAL EDID" is selected for "8.10.1 EDID (P.70)".

By pressing "SET" button shows dialog box, and EDID setting is renewed by pressing "OK" button.

Timing of 720p, 1080i, and 1080p is the same as that of HD signal meeting the CEA-861D standard. For other resolutions, timings meet the VESA DMT or VESA CVT standards.

Set the maximum available resolution for EDID, but the lower resolutions are also supported. Select the resolution responding to the resolution that is output from the connected PC.

[Table 8.12] Supported resolution

Supported resolution / Input resolution settings	640 x 480	800 x 600	1024 x 768	1280 x 720	1280 x 768	1280 x 800	1280 x 960	1280 x 1024	1360 x 768	1366 x 768	1400 x 1050	1440 x 900	1600 x 900	1600 x 1200	1680 x 1050	1920 x 1080i	1920 x 1080p	1920 x 1200	2048 x 1152
800x600	Y	Y	N	N	N	N	N	N	N	N	N	N	N	N	N	N	N	N	N
1024x768	Y	Y	Y	N	N	N	N	N	N	N	N	N	N	N	N	N	N	N	N
1280x720[D4]	Y	Y	Y	Y	N	N	N	N	N	N	N	N	N	N	N	N	N	N	N
1280x768	Y	Y	Y	Y	Y	N	N	N	N	N	N	N	N	N	N	N	N	N	N
1280x800	Y	Y	Y	Y	Y	Y	N	N	N	N	N	N	N	N	N	N	N	N	N
1280x960	Y	Y	Y	Y	Y	Y	Y	N	N	N	N	N	N	N	N	N	N	N	N
1280x1024	Y	Y	Y	Y	Y	Y	Y	Y	N	N	N	N	N	N	N	N	N	N	N
1360x768	Y	Y	Y	Y	Y	Y	Y	Y	Y	N	N	N	N	N	N	N	N	N	N
1366x768	Y	Y	Y	Y	Y	Y	Y	Y	N	Y	N	N	N	N	N	N	N	N	N
1400x1050	Y	Y	Y	Y	N	Y	Y	Y	N	Y	Y	N	N	N	N	N	N	N	N
1440x900	Y	Y	Y	Y	N	Y	Y	Y	N	Y	Y	Y	N	N	N	N	N	N	N
1600x900	Y	Y	Y	Y	N	Y	Y	Y	N	Y	Y	Y	Y	N	N	N	N	N	N
1600x1200	Y	Y	Y	Y	N	Y	Y	Y	N	Y	Y	Y	Y	Y	N	N	N	N	N
1680x1050	Y	Y	Y	Y	N	Y	Y	Y	N	Y	Y	Y	Y	Y	Y	N	N	N	N
1920x1080i[D3]	Y	Y	Y	Y	N	N	N	N	N	N	N	N	N	N	N	Y	N	N	N
1920x1080p[D5]	Y	Y	Y	Y	N	N	Y	Y	N	Y	Y	Y	Y	Y	Y	N	Y	N	N
1920x1200	Y	Y	Y	N	N	Y	Y	Y	N	N	Y	Y	Y	Y	Y	N	Y	Y	N
2048x1152	Y	Y	Y	N	N	N	Y	Y	N	N	Y	Y	Y	Y	Y	N	Y	Y	Y

Y: Supported

N: Not supported

### 8.10.3 Input resolution for AV devices

Menu EDID → AV RESOLUTION

Setting for Each input channel

Setting value

- AUTO [Default    • 480p        • 1080i
- UNUSED            • 720p        • 1080p

You can set the resolution requested to be output from AV devices (such as Blu-ray players).

This setting will be valid if "INTERNAL EDID" is selected for "**8.10.1 EDID (P.70)**".

Normally, set this menu to "AUTO" to set resolution for AV devices according to "**8.10.2 Resolution for PCs (P.71)**" automatically.

"UNUSED" disables the EDID for AV devices. If you select "AUTO" and the resolution output from the PC is different from the resolution set in Properties, the problem may be solved by selecting "UNUSED".

If there is a potential to connect both PCs and AV devices with different resolutions (for example, PC with WXGA (1366x768), Blu-ray disc player with 1080p), set the PC resolution in "**8.10.2 Resolution for PCs**" and select the AV resolution in this menu. However, some PCs and AV devices may choose the higher resolution of the resolutions set in "**8.10.2 Resolution for PCs**" or this menu.

By pressing "SET" button shows dialog box, and EDID setting is renewed by pressing "OK" button.

**[Table 8.13] Input resolutions when "AUTO" is selected**

PC Resolution	800 x 600	1024 x 768	1280 x 720	1280 x 768	1280 x 800	1280 x 960	1280 x 1024	1360 x 768	1366 x 768	1400 x 1050	1440 x 900	1600 x 900	1600 x 1200	1680 x 1050	1920 x 1080i	1920 x 1080p	1920 x 1200	2048 x 1152
AV Resolution	480p		720p												1080i	1080p		

**[NOTE]** If you select "UNUSED", the settings of "**8.10.4 Deep Color (P.73)**", "**8.10.5 Audio format (P.73)**", and "**8.10.6 Speaker configuration (P.74)**" will be disabled and audio is not output because the source device outputs signal through DVI mode.



## 8.10.4 Deep Color

---

Menu	EDID → DEEP COLOR INPUT
Setting for	Each input channel
Setting value	24-BIT COLOR [Default], 30-BIT COLOR

You can set the color depth to be output from the source device.

This menu is valid only if you select "INTERNAL EDID" for "**8.10.1 EDID (P.70)**" and you select a resolution other than "UNUSED" for "**8.10.3 Input resolution for AV devices (P.72)**".

If you select "30-BIT COLOR", compared to "24-BIT COLOR", "30-BIT COLOR" is transmitted using a higher clock frequency, which may cause noise if a cable with a bad quality or a long cable is connected. In such a case, the noise may be removed by setting the color to "24-BIT COLOR".

By pressing "SET" button shows dialog box, and EDID setting is renewed by pressing "OK" button.

## 8.10.5 Audio format

---

Menu	EDID → AUDIO FORMAT
Setting for	Each input channel
Setting value	[Table 8.14] Audio format

[Table 8.14] Audio format

Audio format	ON / OFF	Maximum sampling frequency (kHz)
PCM	Cannot be set	32 / 44.1 / 48 / 88.2 / 96 / 176.4 / 192 (48)
Dolby Digital	Can be set (OFF)	ON: 32 / 44.1 / 48 (48)
AAC	Can be set (OFF)	ON: 32 / 44.1 / 48 / 88.2 / 96 (48)
Dolby Digital+	Can be set (OFF)	ON: 32 / 44.1 / 48 (48)
DTS	Can be set (OFF)	ON: 32 / 44.1 / 48 / 96 (48)
DTS-HD	Can be set (OFF)	ON: 44.1 / 48 / 88.2 / 96 / 176.4 / 192 (192)
Dolby TrueHD	Can be set (OFF)	ON: 44.1 / 48 / 88.2 / 96 / 176.4 / 192 (96)

Default values are shown in parentheses.

You can set the audio format and maximum sampling frequency to be output from a source device.

This menu will be valid only if you select "INTERNAL EDID" for "**8.10.1 EDID (P.70)**" and you select a resolution other than "UNUSED" for "**8.10.3 Input resolution for AV devices (P.72)**".

By pressing "SET" button shows dialog box, and EDID setting is renewed by pressing "OK" button.

### 8.10.6 Speaker configuration

Menu EDID → SPEAKER  
 Setting for Each input channel  
 Setting value Setting mode : AUTO [Default], MANUAL  
 Each speaker : ON, OFF  
 The number of speakers: 1 to 8

[Table 8.15] Default speaker configuration

The number of speakers	FL/FR	LFE	FC	RL/RR	RC	FLC/FRC	RLC/RRC	FLW/FRW	FLH/FRH	TC	FCH
1	OFF	OFF	ON	OFF	OFF	OFF	OFF	OFF	OFF	OFF	OFF
2 [Default]	ON	OFF	OFF	OFF	OFF	OFF	OFF	OFF	OFF	OFF	OFF
3	ON	ON	OFF	OFF	OFF	OFF	OFF	OFF	OFF	OFF	OFF
4	ON	ON	ON	OFF	OFF	OFF	OFF	OFF	OFF	OFF	OFF
5	ON	ON	OFF	ON	OFF	OFF	OFF	OFF	OFF	OFF	OFF
6	ON	ON	ON	ON	OFF	OFF	OFF	OFF	OFF	OFF	OFF
7	ON	ON	ON	ON	ON	OFF	OFF	OFF	OFF	OFF	OFF
8	ON	ON	ON	ON	OFF	OFF	ON	OFF	OFF	OFF	OFF

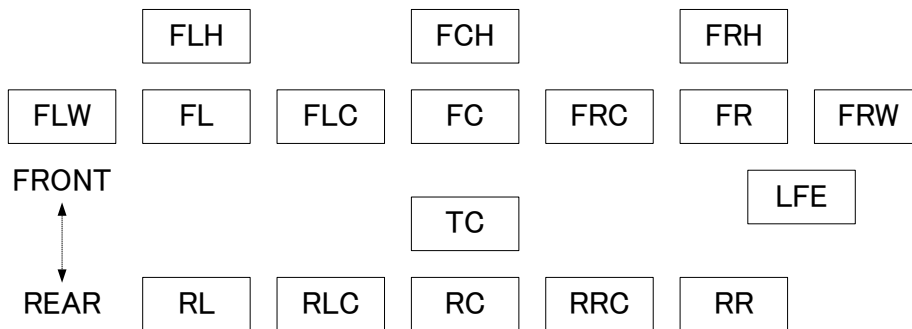

FL	Front Left	RRC	Rear Right Center
FC	Front Center	LFE	Low Frequency Effect
FR	Front Right	FLW	Front Left Wide
FLC	Front Left Center	FRW	Front Right Wide
FRC	Front Right Center	FLH	Front Left High
RL	Rear Left	FCH	Front Center High
RC	Rear Center	FRH	Front Right High
RR	Rear Right	TC	Top Center
RLC	Rear Left Center		

[Figure 8.28] Speaker configuration

You can set the speaker configuration of multi channel audio.

This menu is valid only if you select "INTERNAL EDID" for "**8.10.1 EDID (P.70)**", you select a resolution other than "UNUSED" for "**8.10.3 Input resolution for AV devices (P.72)**".

If you select "AUTO" for the setting mode and set the number of speakers, the speaker configuration will be set to the default setting that is shown in "**[Table 8.15] Default speaker configuration**".

To change the default configuration, set the mode to "MANUAL" and set each speaker to ON/OFF individually. If the number of speakers exceeds the available value, the "DATA INVALID" message is displayed and the settings will not be applied.

By pressing "SET" button shows dialog box, and EDID setting is renewed by pressing "OK" button.

If the number of speakers you specified exceeds stable value, the dialog box gives you a notice and cannot set.

## 8.10.7 Copying EDID

---

Menu EDID → MONITOR EDID COPY

Setting value COPY EDID No.1 and No.2

EDID of the sink device is loaded and registered to the MSD.

Up to eight EDID can be registered.

By pressing "COPY" button shows dialog box, and EDID is copied by pressing "OK" button.

If sink device is not connected to selected output channel, the copy cannot be done.

## 8.11 Communication settings (WEB menu)

You can set communication settings for RS-232C and LAN communications.

[ COMMUNICATION ]																															
RS-232C:	<table border="0"> <tr> <td>BAUD RATE</td> <td>9600bps</td> <td>▼</td> </tr> <tr> <td>① → DATA BIT LENGTH:</td> <td>8</td> <td>▼</td> </tr> <tr> <td>PARITY:</td> <td>NONE</td> <td>▼</td> </tr> <tr> <td>STOP BIT:</td> <td>1</td> <td>▼</td> </tr> <tr> <td></td> <td></td> <td>SET</td> </tr> </table>	BAUD RATE	9600bps	▼	① → DATA BIT LENGTH:	8	▼	PARITY:	NONE	▼	STOP BIT:	1	▼			SET															
BAUD RATE	9600bps	▼																													
① → DATA BIT LENGTH:	8	▼																													
PARITY:	NONE	▼																													
STOP BIT:	1	▼																													
		SET																													
LAN:	<table border="0"> <tr> <td>IP ADDRESS:</td> <td>192</td> <td>168</td> <td>6</td> <td>1</td> <td>SET</td> </tr> <tr> <td>② → SUBNET MASK:</td> <td>255</td> <td>255</td> <td>255</td> <td>0</td> <td>SET</td> </tr> <tr> <td>GATEWAY ADDRESS:</td> <td>192</td> <td>168</td> <td>1</td> <td>200</td> <td>SET</td> </tr> <tr> <td>③ → PORT NUMBER</td> <td>CONNECTION:</td> <td>1</td> <td>▼</td> <td>NO:</td> <td>1100</td> </tr> <tr> <td>④ → MAC ADDRESS:</td> <td colspan="5">00-08-E5-68-00-00</td> </tr> </table>	IP ADDRESS:	192	168	6	1	SET	② → SUBNET MASK:	255	255	255	0	SET	GATEWAY ADDRESS:	192	168	1	200	SET	③ → PORT NUMBER	CONNECTION:	1	▼	NO:	1100	④ → MAC ADDRESS:	00-08-E5-68-00-00				
IP ADDRESS:	192	168	6	1	SET																										
② → SUBNET MASK:	255	255	255	0	SET																										
GATEWAY ADDRESS:	192	168	1	200	SET																										
③ → PORT NUMBER	CONNECTION:	1	▼	NO:	1100																										
④ → MAC ADDRESS:	00-08-E5-68-00-00																														

[Figure 8.29] Communication

- ① 8.11.1 RS-232C communication (P.80)
- ② 8.11.2 IP address/subnet mask/gate way address (P.80)
- ③ 8.11.3 TCP port number (P.81)
- ④ 8.11.4 MAC address (P.81)

## ■ RS-232C communication

The RS-232C connector of the MSD can receive control command from PCs or external control devices.

【See: 6.3.4 Connecting RS-232C cable (P.20)】

【NOTE】 The MSD cannot support following RS-232C communication.

- RS-232C communication from HDC TX/RX's RS-232C connector which is connected HDBaseT input/output of the MSD to the MSD.
- RS-232C bidirectional communication from the MSD's RS-232C connector to HDC TX/RX's RS-232C connector which is connected HDBaseT input/output of the MSD.
- RS-232C bidirectional communication between HDC TX and RX which are connected to the MSD's HDBaseT input/output connectors.

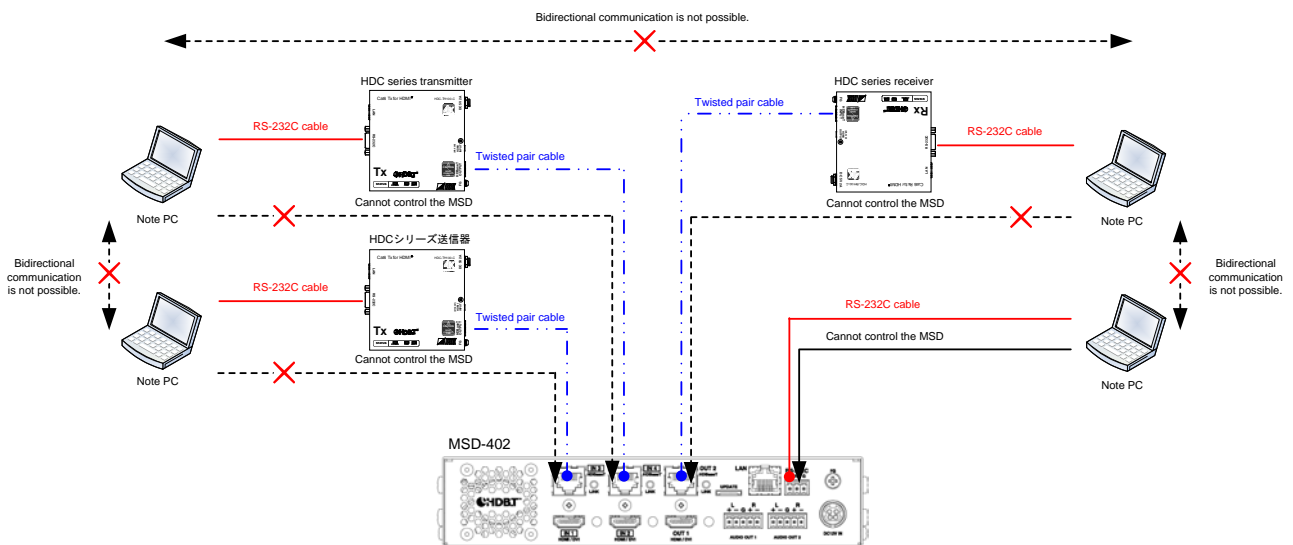

【Figure 8.30】 RS-232C communication

■ LAN communication

The LAN connector of the MSD and the LAN connector of the HDC receiver that is connected to an HDBaseT input or output connectors are all connected by switching hub. All LAN connectors can be used for outputting communication command control from PCs and external control devices, and control from web browser.

The MSD has eight connections and each of those can be set individually. And bidirectional communication is possible between HDC transmitter and receiver through the MSD.

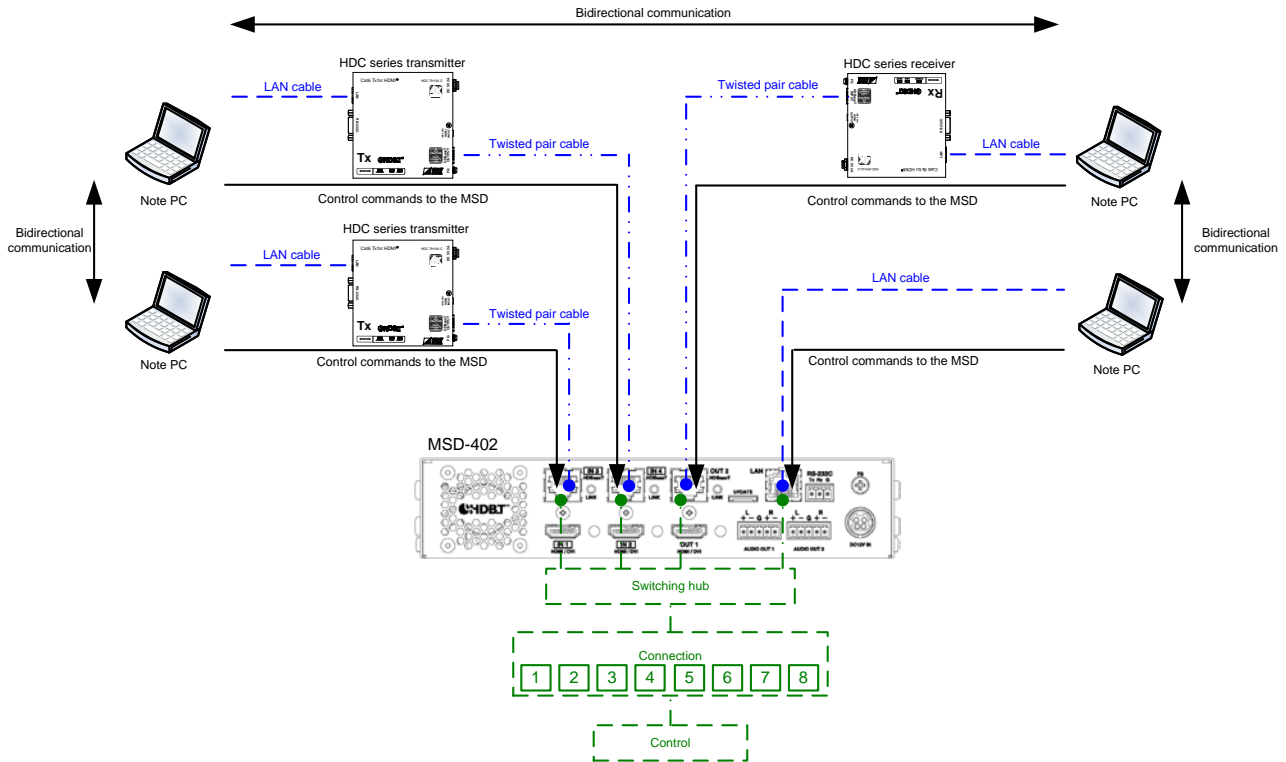

[Figure 8.31] LAN communication

The MSD does not support automatic acquisition of IP address using DHCP (Dynamic Host Configuration Protocol). If you use the MSD in a network with DHCP, keep a fixed IP address. If controlling peripheral devices connected over LAN from the MSD, keep several fixed IP addresses.

■ LAN connection loop issue

The MSD has the function as same as four port switching hub. If you configure following configuration it might cause network loop issue and the network might be down.

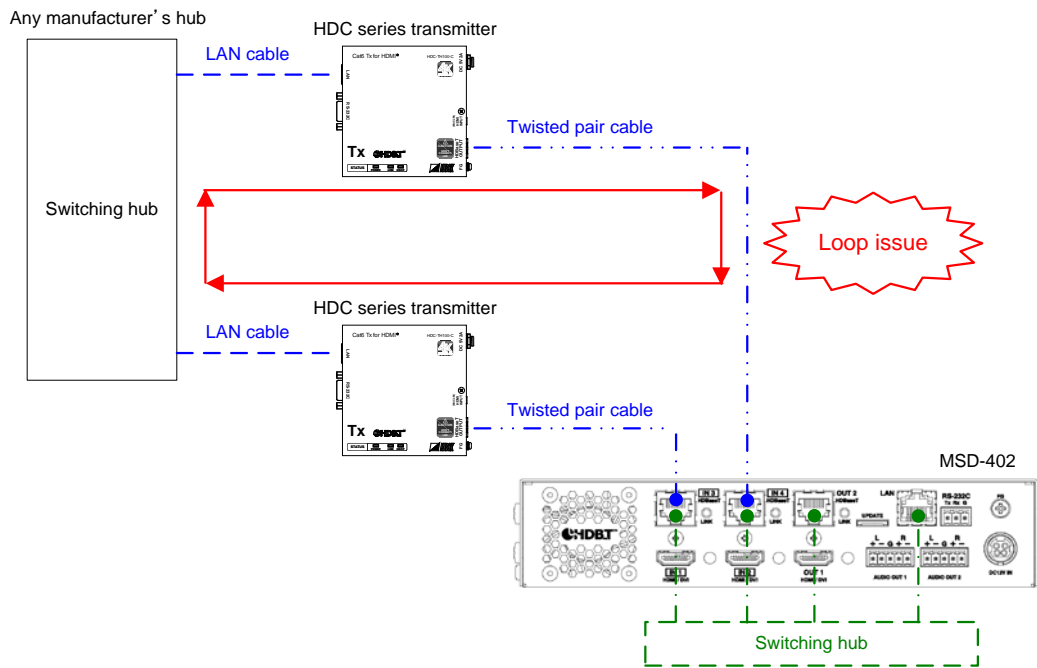

[Figure 8.32] Example of loop issue

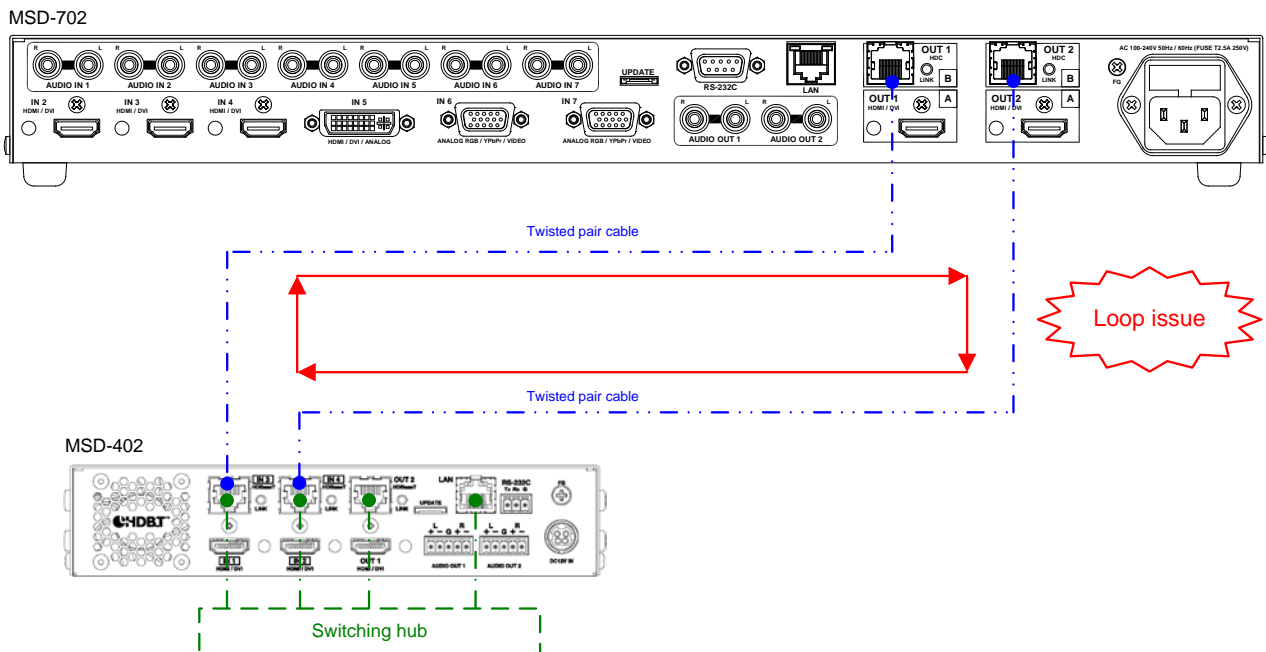

[Figure 8.33] Example of loop issue between IDK products

### 8.11.1 RS-232C communication

---

<b>Menu</b>	Baud rate	: COMMUNICATION → RS-232C → BAUD RATE
	Data bit length	: COMMUNICATION → RS-232C → DATA BIT LENGTH
	Parity check	: COMMUNICATION → RS-232C → PARITY
	Stop bit	: COMMUNICATION → RS-232C → STOP BIT

**Setting value** [Table 8.16] RS-232C settable items

[Table 8.16] RS-232C settable items

Setting item	Setting value	Default
Baud rate [bps]	4800, 9600, 19200, 38400	9600
Data bit length [bit]	8, 7	8
Parity check	NONE, EVEN, ODD	NONE
Stop bit [bit]	1, 2	1

You can set RS-232C communication.

By pressing "SET" button shows dialog box, and RS-232C communication setting is renewed by pressing "OK" button.

### 8.11.2 IP address/subnet mask/gate way address

---

<b>Menu</b>	IP address	: COMMUNICATION→LAN→IP ADDRESS
	Subnet mask	: COMMUNICATION→LAN→SUBNET MASK
	Gateway address	: COMMUNICATION→LAN→GATEWAY ADDRESS
<b>Setting value</b>	IP address	: 192.168.1.199 [Default]
	Subnet mask	: 255.255.255.0 [Default]
	Gateway address	: 192.168.1.200 [Default]

You can set IP address, subnet mask, and gateway address.

By pressing "SET" button shows dialog box, and LAN communication setting is renewed by pressing "OK" button. If the values you specified exceed settable range you cannot set or renew LAN communication settings.



### 8.11.3 TCP port number

---

Menu COMMUNICATION → LAN → PORT NUMBER

Setting for Each connection

Setting value **[Table 8.17] Settings of TCP port number**

**[Table 8.17] Settings of TCP port number**

For	Setting value
Communication command control	23,1100,6000 to 6999
WEB browser control	80,5000 to 5999

[Default] Connections 1 to 3 = 1100; Connections 4 to 6 = 23;  
Connections 7, 8 = 80

You can set the TCP port number.

Each connection can be divided by port number for control command and control from web browser.

By pressing "SET" button shows dialog box, and LAN communication setting is renewed by pressing "OK" button. If the values you specified exceed settable range you cannot set to renew LAN communication settings.

### 8.11.4 MAC address

---

Menu COMMUNICATION → LAN → MAC ADDRESS

You can display the MAC address.

## 8.12 Preset memory (WEB menu)

You can set crosspoint memory, preset memory and start up memory from this page.

[Figure 8.34] Preset memory

- ① 8.12.1 Loading cross point (P.83)
- ② 8.12.2 Saving cross point (P.83)
- ③ 8.12.3 Editing cross point (P.84)
- ④ 8.12.4 Loading all settings (P.84)
- ⑤ 8.12.5 Saving all settings (P.85)
- ⑥ 8.12.6 Copying output setting (P.86)
- ⑦ 8.12.7 Startup setting (P.87)

## 8.12.1 Loading cross point

Menu **PRESET MEMORY** → **LOAD CROSS POINT**

Setting value No.1 to No.4

You can load the I/O channel settings of video and audio saved in the cross point memory.

By pressing "LOAD" button shows dialog box, and crosspoint memory is loaded by pressing "OK" button.

## 8.12.2 Saving cross point

Menu **PRESET MEMORY** → **SAVE CROSS POINT**

Setting value No.1 to No.4

You can save the I/O channel settings of video and audio into the cross point memory.

Up to four cross point memories can be saved with their name (up to 10 characters). If you set "---" (not control) for "**8.12.3 Editing cross point (P.84)**", a writing method (CONTINUE or DELETE) can be selected. Setting of "**8.3.2 PinP output (P.35)**" is also saved at the same time.

By pressing "SAVE" button shows dialog box, and crosspoint memory is saved by pressing "OK" button.

### ■ Writing method

"CONTINUE": "---" (not control) will be kept in the cross point memory.

"DELETE": the current input channel settings will be overwritten.

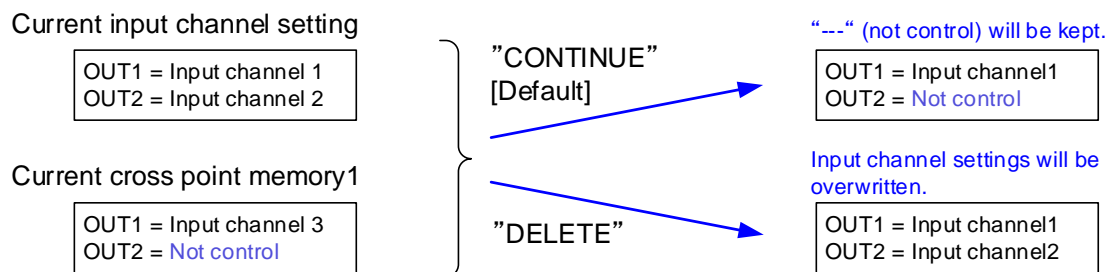

[Figure 8.35] Saving cross point

### 8.12.3 Editing cross point

Menu PRESET MEMORY → EDIT CROSS POINT

Setting for Each cross point memory

Setting value **[Table 8.18] Editing items of cross point**

**[Table 8.18] Editing items of cross point**

Setting item	Setting value	Default
Memory name (NAME)	20 to 7D of ASCII code	20 (space)
Input channel (Each output channel)	---, 1 to 4, OFF	---

You can edit the settings of the cross point memory.

Selects memory number and edit items of crosspoint in **[Table 8.18] Editing items of cross point**.

Each memory name can be register up to 10 characters. You cannot edit settings of “**8.3.2 PinP output (P.35)**” saved in crosspoint memory.

By pressing “SAVE” button shows dialog box, and crosspoint memory is saved by pressing “OK” button.

#### ■ Not controlling channel

“---”: if you select “---” when setting input channel of V or A, it is set to “not control”. Output with the setting will not be switched.

Current input setting

OUT1 = Input channel1  
OUT2 = Input channel2

Loading →

Setting is not changed.

Current setting of cross point memory1

OUT1 = Input channel3  
OUT2 = Not control (---)

OUT1 = Input channel3  
OUT2 = Input channel2

Input setting after loading cross point memory

**[Figure 8.36] Loading edited cross point memory**

### 8.12.4 Loading all settings

Menu PRESET MEMORY → LOAD ALL SETTING

Setting value No.1 to No.4

You can load all settings saved in the preset memory.

Once you perform this operation, all settings related to video and audio I/O except for some environmental settings will be updated. Operate this menu with great attention.

This menu is not selected if setting is not saved in memory. Since no setting is saved in any memories by factory default, this menu is not selected.

By pressing “LOAD” button shows dialog box, and all settings are loaded by pressing “OK” button.

**[See: 8.12.5 Saving all settings (P.85) ]**

## 8.12.5 Saving all settings

Menu **PRESET MEMORY** → **SAVE ALL SETTING**

Setting value No.1 to No.4

You can save up to four preset memories (up to 10 characters) of the following settings:

By pressing "SAVE" button shows dialog box, and all settings are saved by pressing "OK" button.

**[Table 8.19] Settings can be saved in preset memory**

Menu	Item
Switching input channel (P.23)	Switching input channel, PinP output
Output timing (WEB menu) (P.38)	Output resolution, Aspect ratio for sink device, Aspect ratio, Aspect ratio control, Overscan, Display position, Display size, Masking, Background color, Test pattern
Quality settings (WEB menu) (P.47)	Sharpness, Brightness, Contrast, HUE, Saturation Black level, Gamma
Input settings (WEB menu) (P.51)	No-signal input monitoring, Setting HDCP input, Input equalizer, Automatic detection of input video interruption, Priority of input channel automatic switching, Masking time after automatic switching of input channel
Input timing (WEB menu) (P.56)	The total number of horizontal dots, Start position, Active area
Output settings (WEB menu) (P.59)	Output mode, Synchronous signal output with no input video, Output video with no input video, Window transition effect, Window transition speed, Wipe color, HDCP output, The number of HDCP retries, Deep Color, CEC connection
Audio settings (WEB menu) (P.64)	Output level, Output mute, Input level, Audio output connector, Multi channel audio output, Test tone
EDID: Extended Display Identification Data (WEB menu) (P.68)	EDID, Resolution for PCs, Input resolution for AV devices, Deep Color, Audio format, Speaker configuration

## 8.12.6 Copying output setting

Menu **PRESET MEMORY** → **COPY OUTPUT MEMORY**

Setting value **OUT1** → **OUT2**, **OUT2** → **OUT1**

You can copy output setting from one output to another output. PinP output settings are also copied at the same time. By pressing "COPY" button shows dialog box, and output settings are copied by pressing "OK" button.

**[Table 8.20] Settings can be copied**

Menu	Item
Switching input channel (P.23)	Switching input channel, PinP output
Output timing (WEB menu) (P.38)	Output resolution, Aspect ratio for sink device, Output Display position, OutputDisplay size, Output Masking, Background color, Test pattern
Quality settings (WEB menu) (P.47)	Output Brightness, Output Contrast, Gamma
Output settings (WEB menu) (P.59)	Output mode, Synchronous signal output with no input video, Output video with no input video, Window transition effect, Window transition speed, Wipe color, HDCP output, The number of HDCP retries, Deep Color, CEC connection
Audio settings (WEB menu) (P.64)	Output level, Output mute, Audio output connector, Multi channel audio output, Test tone
Setting bitmap (WEB menu) (P.88)	Outputting bitmap image, Background color, Aspect ratio, Display position Input channel assignment, Bitmap output at startup

**【NOTE】** CEC connection is only for one by one connection. It cannot connect multiple input and output. If CEC setting becomes one input to multiple outputs by copying CEC, lower number of output channel has priority and others become non-connect.

## 8.12.7 Startup setting

Menu  PRESET MEMORY → START UP

Setting value [Table 8.21] Startup settings

You can set the memory loading at startup.

[Table 8.21] Startup settings

Item	Setting value	Operation at startup
Last channel	LAST CHANNEL [Default]	Starts with the setting las time the MSD powered off.
Preset memory	PRESET MEMORY 1 to PRESET MEMORY 4 <sup>*</sup>	Starts with the settings saved in the preset memory. For settings that are not saved in the preset memory, it starts up with the settings of the last MSD power off.
Cross point memory	CROSS POINT 1 to CROSS POINT 4	Starts with the channel settings saved in the selected cross point memory. For settings other than channel settings, starts up with the settings of the last MSD power off.
Channel OFF	CHANNEL OFF	Channel setting will be OFF. For settings other than channel setting, starts up with the settings of the last MSD power off.

\*Only registered preset memory numbers can select from pull down list.

## 8.13 Setting bitmap (WEB menu)

You can set bitmap settings from this page.

Setting conditions are different between top side of the center line and bottom side of the center line. Settings on top side of the center line can select channel from tabs, and settings on bottom side of the center line are common setting items for all channels.

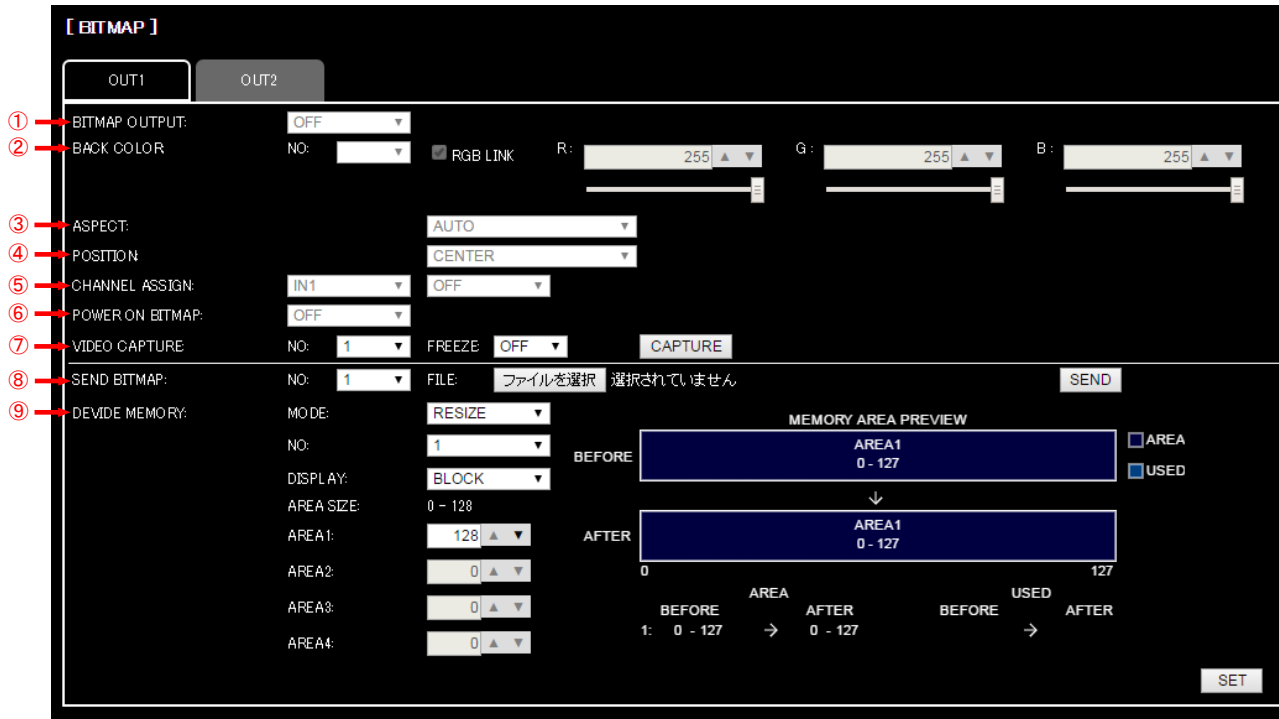

[Figure 8.37] Bitmap

- ① 8.13.2 Outputting bitmap image (P.90)
- ② 8.13.3 Background color (P.90)
- ③ 8.13.4 Aspect ratio (P.91)
- ④ 8.13.5 Display position (P.91)
- ⑤ 8.13.6 Input channel assignment (P.92)
- ⑥ 8.13.7 Bitmap output at startup (P.92)
- ⑦ 8.13.9 Input image capture (P.95)
- ⑧ 8.13.1 Sending bitmap file (P.89)
- ⑨ 8.13.8 Dividing memory area (P.92)



### 8.13.1 Sending bitmap file

Menu BITMAP→SEND BITMAP

You can set the bitmap image to be displayed on the sink device. Up to four bitmaps can be registered. IDK's logo is displayed by factory default.

Bitmaps can be enlarged but cannot be reduced. The larger the resolution is, the longer the output time will be, and it may take a maximum of approximately six seconds to output a bitmap. Register a bitmap having smaller resolution than that of the sink device.

#### ■ Conditions of bitmap file

The MSD supports DIB (Device Independent Bitmap) with a header generally used for Windows, and those files have to meet the following requirements:

[Table 8.22] Conditions of bitmap file

Item	condition
File header	"BITMAPFILEHEADER"
Information header	"BITMAPCOREHEADER"(for OS/2) / "BITMAPINFOHEADER"(for Windows)
The number of colors	2 colors (monochrome, 1 bit), 16 colors (4 bits), 256 colors (8 bits), 16.77 million colors (TRUE COLOR, 24 bits)
Resolution	The maximum resolution: [Horizontal resolution x Vertical resolution x The number of bytes per pixel] = 8,388,608 bytes or less. If you register several bitmaps, the total bytes of all bitmaps should be 8,388,608 bytes or less. (Aspect ratio does not matter as long as it is within the maximum resolution). Bytes per pixel: 1 byte per pixel for 2 colors (monochrome, 1 bit), 16 colors (4 bits), and 256 colors (8 bits); 3 bytes per pixel for 16.77 million colors (TRUE COLOR, 24 bits).
Compression format	No compression (BI_RGB), 8 bit-run-length compression (BI_RLE8), 4 bit-run-length compression (BI_RLE4)

#### ■ Transferring bitmap file

If you divide memory area, please select register area for bitmap file, then select bitmap file.

By pressing "SEND" button shows dialog box, and bitmap file transfer is started by pressing "OK" button.

If the transferring is done correctly you can have message on dialog box, then press "OK" button to finish.

Please do not operate other web menu or turn off the MSD's power until the transferring is done and bitmap is registered. If the transferring is failed you will have following error messages;

[Table 8.23] Error message

Error message	Error description
File Name is invalid.	The file name was specified incorrectly.
File Format Error is happened.	The MDS does not support this file.
File Size exceeds the capacity.	The resolution exceeds the maximum resolution.。
Memory Allocation Error is happened.	Enough memory to save the bitmap file temporarily could not be allocated. You may solve this error by turning OFF/ON the MSD main power switch and sending the bitmap file again.

### 8.13.2 Outputting bitmap image

---

**Menu** BITMAP → BITMAP OUTPUT  
**Setting for** Each output channel  
**Setting value** OFF [Default], ON (BITMAP1 ON to BITMAP4 ON)

You can enable/disable the bitmap image output.

If several bitmaps are registered, select the bitmap number you want to output.

If there is no bitmap registered, you cannot set.

### 8.13.3 Background color

---

**Menu** BITMAP → BACKGROUND COLOR  
**Setting for** Each output channel, each bitmap  
**Setting value** R / G / B: 0 to 255 [Default]: R / G / B: 255 (white)

You can set the background color of bitmap.

If you check "RGB LINK" check box, only settings of "R" can be set, and "G" and "B" change relatively.

If there is no bitmap registered, you cannot set.

### 8.13.4 Aspect ratio

Menu BITMAP → ASPECT  
 Setting for Each output channel, each bitmap  
 Setting value **[Figure 8.38] Setting aspect ratio**

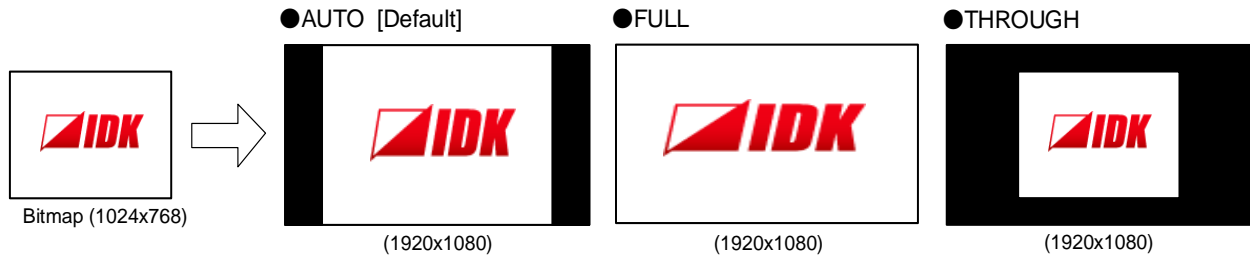

**[Figure 8.38] Setting aspect ratio**

You can set the aspect ratio of bitmap.

If you select “AUTO”, the aspect ratio is kept. However, if either of horizontal or vertical is enlarged and the other is reduced, the aspect ratio cannot be kept. In such a case, the image is displayed using “THROUGH” automatically to keep the aspect ratio.

### 8.13.5 Display position

Menu BITMAP → POSITION  
 Setting for Each output channel, each bitmap  
 Setting value **[Figure 8.39] Display position**

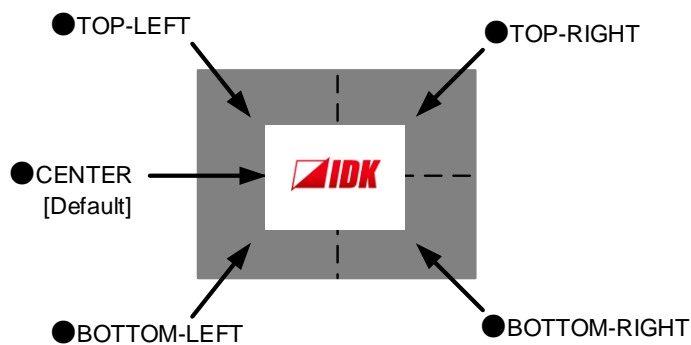

**[Figure 8.39] Display position**

You can set the display position of the bitmap.  
 If there is no bitmap registered, you cannot set.

### 8.13.6 Input channel assignment

---

Menu	BITMAP → CHANNEL ASSIGN	
Setting for	Each input channel, each output channel	
Setting value	Input channel	: IN1 to IN4 [Default] IN1
	Registered bitmap	: OFF [Default] BITMAP1 ON to BITMAP4 ON

A bitmap can be treated as an input video source by assigning the bitmap to any input that is not currently being used. Set “**8.13.2 Outputting bitmap image (P.90)**” to “OFF”.

If you switch a normal image to a bitmap image, it takes longer time to output the image, and you cannot perform other operations while the bitmap is being written and displayed. If there is no bitmap registered, you cannot set.

### 8.13.7 Bitmap output at startup

---

Menu	BITMAP → POWER ON BITMAP	
Setting for	Each output channel	
Setting value	OFF [Default], BITMAP1 ON to BITMAP4 ON	

You can enable or disable bitmap output at the time of the MSD startup. If there is no bitmap registered, you cannot set.

### 8.13.8 Dividing memory area

---

Menu	Top→BITMAP→DIVIDE MEMORY	
Setting value	[Table 8.24] Dividing memory area	

You can register up to four bitmaps within the available memory area by dividing the memory. You can select one of three dividing modes or specify the size you want to divide manually.

Memory areas are controlled by blocks. 1 block = 64K bytes; 128 blocks = 8M bytes in total

By pressing “SET” button shows dialog box, and memory dividing is executed by pressing “OK” button.

[Table 8.24] Dividing memory area

Setting item	Setting value	Default
MODE (dividing mode)	RESIZE,DELETE,AUTO	RESIZE
NUMBER (the number of partitions)	1 to 4	1
DISPLAY (displaying method)	BLOCK,BYTE	BLOCK
End block position	0 to 127	127

## ■ Preview of memory dividing result

You can preview the results of memory dividing.

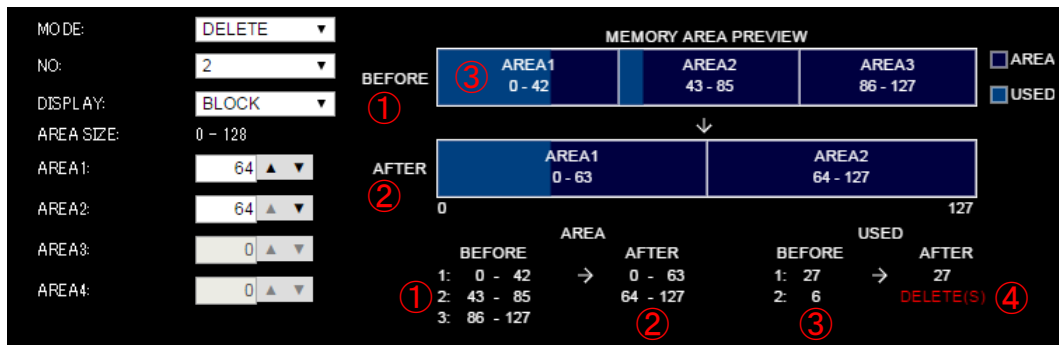

[Figure 8.40] MEMORY AREA PREVIEW

- ① Current memory area
- ② Memory area after dividing
- ③ Memory area where bitmap is registered
- ④ Alert message: this message is displayed when registered bitmap is deleted.

[Table 8.25] Alert message

Message	Condition
DELETE (S)	When bitmap is going to delete because the start position of memory area is changed.
DELETE (E)	When bitmap is going to delete because the end position of memory area is changed.

## ■ Displaying method

You can switch how to display memory size area regarding items which are specified in “[Table 8.26] Displaying method for memory size area”. When you directly type memory area size value, the unit follows the selected displaying method.

[Table 8.26] Displaying method for memory size area

Item	Details
MEMORY AREA PREVIEW	Current (BEFORE) memory area start and end position.
	After dividing (AFTER) memory area start and end position.
	Registered position of bitmap (If bitmap is registered)
AREA SIZE	Memory side after memory dividing

### “BLOCK”

It shows memory area as “Block”.

### “BYTE”

It shows memory area as “Byte”.

■ Dividing mode

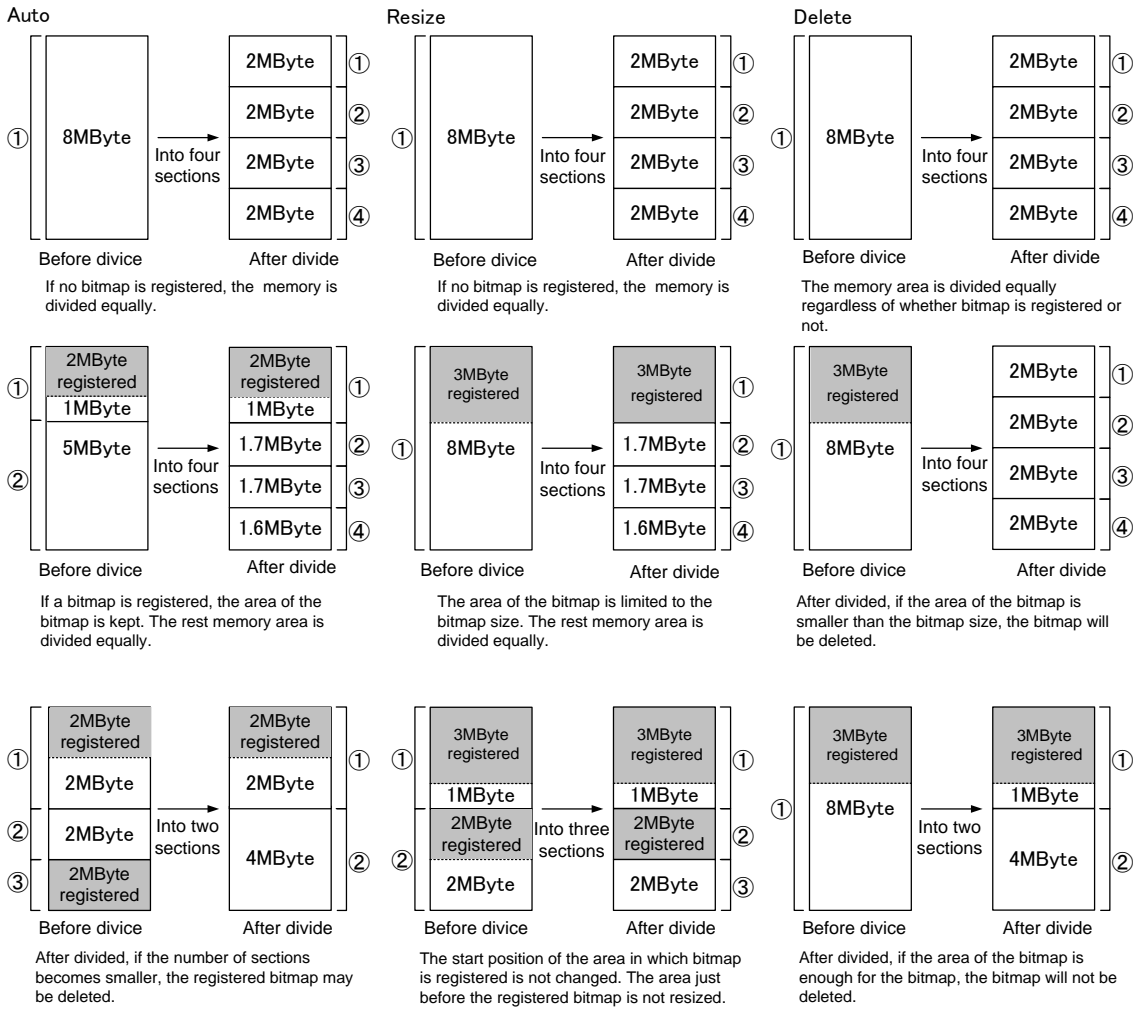

[Figure 8.41] Dividing mode

## 8.13.9 Input image capture

Menu  BITMAP → VIDEO CAPTURE

Setting value [Table 8.27] Setting items for input video capture

[Table 8.27] Setting items for input video capture

Setting item	Setting value	Default
Register number	No.1 to No.4	No.1
FREEZE	OFF / ON	OFF

An input video can be treated as a bitmap by capturing the input video. The maximum resolution has to be [Horizontal resolution x Vertical resolution x 3 (the number of bytes per pixel; "3" is fixed)] = 8,388,608 bytes or less. If you register several bitmaps and captured video, the total resolution of all bitmaps and captured videos has to be 8,388,608 bytes or less (aspect ratio does not matter).

Captured images can be displayed in the same size or enlarged size but not in the reduced size. Larger resolutions require a longer writing time; it may take approximately six seconds at a maximum to write a bitmap. Register images with lower resolution than that of the sink device. (If an input image is larger than the output image, capture it with reduced image size. If an input image is the same size or smaller, capture the image without changing its size. You can register images with lower resolution by setting "8.4.1 Output resolution (P.40)" to smaller value and capture the images.)

---

**[NOTE]** When output video image is captured and 8.3.2 PinP output (P.35) is "ON", the captured image is does not have PinP.

---

### ■ How to capture video image

If you divide memory area, please select register area for captured video image. Then set to freeze function "ON". "Freeze" is temporary and if you switch input channel or input signal is changed, "Freeze" become "OFF" automatically. By pressing "CAPTURE" button shows dialog box, and video capturing is started by pressing "OK" button. If the video capturing is done correctly you can have message on dialog box, then press "OK" button to finish.

Please do not operate other web menu or turn off the MSD's power until the capturing is done and registered. If the video capturing is failed you will have following error messages;

[Table 8.28] Error message

Error message	Error description
Video Capture is not available because there is no input signal.	There is no input signal. Video capture cannot execute.
Memory Size Error is happened.	The captured video image cannot be saved because the size of the captured image exceeds available memory area.

## 8.14 Other settings (WEB menu)

You can set other settings from this page.

[ OTHERS ]	
① → STARTUP KEY LOCK:	AUTO ▼
② → AUTO RELOAD TIME:	OFF ▼
③ → BACKUP/RESTORE:	BACKUP ファイルを選択 選択されていません RESTORE
④ → INITIALIZE	NORMAL INITIALIZE ALL INITIALIZE
⑤ → VERSION	MSD-402 1.00

[Figure 8.42] Other settings

- ① 8.14.1 Startup setting for key lock (P.97)
- ② 8.14.2 Automatic reload time (P.97)
- ③ 8.14.3 Backup and restore all settings (P.97)
- ④ 8.14.4 Initialization (WEB menu) (P.98)
- ⑤ 8.14.5 Displaying version (P.98)



### 8.14.1 Startup setting for key lock

---

Menu  OTHERS → STARTUP KEY LOCK  
Setting value AUTO [Default], UNLOCK, LOCK

You can set key lock for when the MSD is powered on.  
AUTO: the previous key lock mode will be applied.

### 8.14.2 Automatic reload time

---

Menu  OTHERS → AUTO RELOAD TIME  
Setting value OFF [Default], 1s to 10s (by 1sec)

You can set automatic reload time for CROSS POINT and STATUS page.  
If you set to "OFF", the pages are not reloaded until reloaded by manually. Automatic reload is not supported on other pages.

【See: 8.3 Crosspoint operation (WEB menu) (P.34)】

【See: 8.15 Displaying status (WEB menu) (P.99)】

### 8.14.3 Backup and restore all settings

---

Menu  OTHERS → BACKUP/RESTORE

You can save backup file of all settings of the MSD to PC.  
By pressing "BACKUP" button shows dialog box, and backup file is saved by pressing "OK" button.

You can restore all the MSD settings from the backup files. Select backup file first. By pressing "RESTORE" button shows dialog box, and restore is executed by pressing "OK" button.

If the restoring is done correctly you can have message on dialog box, then press "OK" button to finish.  
Please do not operate other web menu or turn off the MSD's power until the restoring is done and registered.  
If the video capturing is failed you will have following error messages;

## 8.14.4 Initialization (WEB menu)

---

Menu OTHERS → INITIALIZE

You can initialize the MSD.

If you press "NORMAL INITIALIZE" button, the MSD will be initialized except LAN communication settings. This function is useful when you operate the MSD from WEB browser. IP address, subnet mask, gateway address, and TCP port number are not initialized by "NORMAL INITIALIZE".

【 See: 8.11.2 IP address/subnet mask/gate way address (P.80) 】

【 See: 8.11.3 TCP port number (P.81) 】

If you press "ALL INITIALIZE" button, the MSD will be initialized and become factory default. You can execute "ALL INITIALIZE" from front panel.

【 See: 7.4 Initialization (P.25) 】

## 8.14.5 Displaying version

---

Menu OTHERS → VERSION

You can display the product name and firmware version.

## 8.15 Displaying status (WEB menu)

You can confirm input and output signal status from this page.

[STATUS]						
①	INPUT STATUS	VIDEO STATUS	: IN1	IN2	IN3	IN4
		FORMAT	: 1080p 59.94Hz	1080p 59.94Hz	1080p 59.94Hz	1080p 59.94Hz
		INPUT MODE	: HDMI MODE	HDMI MODE	HDMI MODE	HDMI MODE
		HDCP	: ON	ON	ON	ON
		COLOR SPACE	: YCbCr 4:4:4	YCbCr 4:4:4	YCbCr 4:4:4	YCbCr 4:4:4
		DEEP COLOR	: 24-BIT COLOR	24-BIT COLOR	24-BIT COLOR	24-BIT COLOR
		AUDIO STATUS	: IN1	IN2	IN3	IN4
		FORMAT	: LINEAR PCM	LINEAR PCM	LINEAR PCM	LINEAR PCM
		SAMPLING FREQUENCY	: 48.0kHz	48.0kHz	48.0kHz	48.0kHz
		CHANNEL	: 2 CHANNEL	2 CHANNEL	2 CHANNEL	2 CHANNEL
		SPEAKER	: FL FR --	FL FR --	FL FR --	FL FR --
		BIT LENGTH	: 24 BITS	24 BITS	24 BITS	24 BITS
		②	MONITOR STATUS	HDCP AUTHENTICATION	: HDCP SUPPORT	HDCP SUPPORT
OUTPUT MODE	: HDMI MODE			HDMI MODE		
DEEP COLOR	: 24-BIT COLOR			24-BIT COLOR		
VIDEO ERROR STATUS	:					
DIGITAL AUDIO ERR STATUS	:					
ANALOG AUDIO ERR STATUS	:					
③	EDID STATUS	MONITOR NAME	: OUT1	OUT2		
		RESOLUTION	: MSD-804FD	MSD-804FD		
		HDMI/DVI	: 1920x1080 148.50MHz	1920x1080 148.50MHz		
		COLOR SPACE	: HDMI MODE	HDMI MODE		
		DEEP COLOR	: RGB/YCbCr 422/444	RGB/YCbCr 422/444		
		PCM FREQUENCY	: 24BIT COLOR	24BIT COLOR		
		PCM BIT LENGTH	: 32/44.1/48kHz	32/44.1/48kHz		
		PCM CHANNEL	: 16/20/24BIT	16/20/24BIT		
		COMPRESSED AUDIO	: 2 CHANNEL	2 CHANNEL		
			: Not Supported	Not Supported		

[Figure 8.43] Input and output signal status

- ① 8.15.1 Input signal status (P.100)
- ② 8.15.2 Sink device status (P.103)
- ③ 8.15.3 Displaying EDID of sink device (P.105)

## 8.15.1 Input signal status

Menu **STATUS** → **INPUT STATUS**

Setting value **[Table 8.29] Input signal status**

You can confirm the input signal status that is from video input connectors.

**[Table 8.29] Input signal status**

VIDEO STATUS	Signal status	AUDIO STATUS	Signal status
FORMAT	Input signal resolution	FORMAT	Audio signal type
INPUT MODE	Input signal type	SAMPLING FREQUENCY	Sampling frequency
HDCP	HDCP status	CHANNEL	The number of channels
COLOR SPACE	Color space	SPEAKER	Speaker configuration
DEEP COLOR	Color depth	BIT LENGTH	Sampling bit length

### VIDEO STATUS

#### ■ Input signal resolution

**[Table 8.30] Input signal resolution**

Display simple	Signal Type	Discription
1080p 59.94Hz	SDTV / HDTV	Format type, Vertical synchronized frequency
800 x 600 60.00Hz	RGB	Horizontal / Vertical resolution, Vertical synchronized frequency
NO SIGNAL	No video input	

If sampling clock (Horizontal synchronized frequency x the number of horizontal dots) exceeds 165 MHz, status shows (E) and the MSD does not output video signal.

## ■ Input signal type

**[Table 8.31] Input signal type**

Display simple	Signal
HDMI MODE	HDMI signal
DVI MODE	DVI signal
	No video input

## ■ HDCP status

**[Table 8.32] HDCP status**

Display simple	Discription
ON	The signal is protected by HDCP
OFF	The signal is not protected by HDCP
	No video input

## ■ Color space

**[Table 8.33] Color space**

Display simple	Signal
YCbCr 4:4:4	YCbCr 4:4:4
YCbCr 4:2:2	YCbCr 4:2:2
RGB	RGB signal
	No video input

## ■ Color depth

**[Table 8.34] Color depth**

Display simple	Discription
24-BIT COLOR	24-BIT COLOR signal
30-BIT COLOR	30-BIT COLOR signal
	No video input

## AUDIO STATUS

## ■ Audio signal type

[Table 8.35] Audio signal type

Display simple	Signal
LINEAR PCM	Linear PCM
COMPRESSED AUDIO	Compressed audio (Dolby Digital, DTS, etc...)
NO SIGNAL	No audio input

## ■ Sampling frequency

[Table 8.36] Sampling frequency

Display simple	Discription
48.0kHz	Audio signal sampling frequency
96.0kHz	
	No audio input

## ■ The number of channels

[Table 8.37] The number of channels

Display simple	Discription
2 CHANNEL	2 channels
MULTI CHANNEL	Multi channels
	No audio input

## ■ Speaker configuration

[Table 8.38] Speaker configuration

Display simple	Discription
FL FR - - - - -	2 channels speaker configuration
FL FR LFE FC RL RR RLC RRC	7.1 channels speaker configuration
	No audio input

【 See: 8.10.6 Speaker configuration (P.74) 】

## ■ Sampling bits

[Table 8.39] Sampling bits

Display simple	Discription
16 BITS	Sampling bits of audio signal
24 BITS	
	No audio input

## 8.15.2 Sink device status

Menu  STATUS → MONITOR STATUS

Setting value [Table 8.40] Monitor status

You can confirm the sink device status.

**[Table 8.40] Monitor status**

MONITOR STATUS	Sink device status
HDCP AUTHENTICATION	HDCP authentication status
OUTPUT MODE	Output signal type
DEEP COLOR	Color depth
VIDEO ERROR STATUS	Error message (video output)
DIGITAL AUDIO ERR STATUS	Error message (digital audio output)
ANALOG AUDIO ERR STATUS	Error message (analog audio output)

### ■ HDCP authentication status

**[Table 8.41] HDCP authentication status**

HDCP authentication status	Discription
HDCP SUPPORT	HDCP-compliant sink device is connected.
HDCP NOT SUPPORT	Non-HDCP-compliant sink device is connected.
HDCP ERROR	HDCP-compliant sink device is connected, but the authentication failed.
HDCP CHECK NOW	Status of sink device is being checked.
MONITOR DISCONNECT	Monitor is disconnected (displayed only for 1 second)
Cat6 LINK DISCONNECT	Cat6 / Cat5e cable is disconnected.
Cat6 NO LINK	Cat6 / Cat5e cable is not connected.
UNCONNECTED	No sink device is connected.

### ■ Output signal type

**[Table 8.42] Output signal type**

Display simple	Discription
HDMI MODE	HDMI signal
DVI MODE	DVI signal
	No sink device is connected.

### ■ Color depth

**[Table 8.43] Color depth**

Display simple	Discription
24-BIT COLOR	24-BIT COLOR signal
30-BIT COLOR	30-BIT COLOR signal
	No sink device is connected.

## ■ Error message

**[Table 8.44] Error message (video output)**

Error message	Description
	No message means that video output has no problem.
Not DDC Power	DDC power is not supplied. (If source device is not connected, status shows this message.)
No Signal	No video input signal
AV Mute Received	Source device output is mute.
HDCP Video Mute	Input signal has HDCP but sink device does not support HDCP. (This message might be shown during HDCP authentication also)
Not AVInfoFrame	Source device does not output information (packet) which is needed to output video signal.
Dot Clock Over	Unsupported signal is input to the MSD.
Channel OFF	Input channel is set to "OFF".

**[Table 8.45] Error message (digital audio output)**

Error message	Audio output
	No message means that audio output has no problem.
Audio Mute	<b>8.9.2 Output mute (P.66)</b> is set to "ON".
Not DDC Power	DDC power is not supplied. (If source device is not connected, status shows this message.)
No Signal	No audio input signal
AV Mute Received	Source device audio output is mute.
HDCP Audio Mute	Input signal has HDCP but sink device does not support HDCP. (This message might be shown during HDCP authentication also)
Not AUDInfoFrame	Source device does not output information (packet) which is needed to output audio signal.
Compressed Audio	The MSD cannot output audio signal because compressed audio signal is input. (The MSD can only output compressed audio to sink device which supports compressed audio)
Digital Out OFF	<b>8.9.3 Audio output connector (P.66)</b> is set to "ANALOG".
DVI Mode	<b>8.8.1 Output mode (P.60)</b> is set to "DVI MODE" or sink device does not support audio.
Channel OFF	Input channel is set to "OFF".

**[Table 8.46] Error message (analog audio output)**

Error message	Audio output
	No message means that analog audio output has no problem.
Audio Mute	<b>8.9.2 Output mute (P.66)</b> is set to "ON"
Analog Out OFF	<b>8.9.3 Audio output connector (P.66)</b> is set to "DIGITAL".
Channel OFF	Input channel is set to "OFF".



### 8.15.3 Displaying EDID of sink device

Menu  STATUS → MONITOR STATUS

Setting value **[Table 8.47] EDID information of sink device**

You can display EDID information of the sink device that is connected to the video output connector. "UNCONNECTED" is displayed at "MONITOR NAME" if sink devices are not connected to the video output connectors. "EDID READ ERROR" is displayed at "MONITOR NAME" if the MSD cannot read EDID from sink devices.

**[Table 8.47] EDID information of sink device**

EDID STATUS	Discription
MONITOR NAME	Sink device name
RESOLUTION	Supported resolution, dot clock
HDMI/DVI	HDMI mode or DVI mode (HDMI supported or not)
COLOR SPACE	Sampling structure
DEEP COLOR	Color depth
PCM FREQUENCY	Audio sampling frequency of linear PCM audio
PCM BIT LENGTH	Audio sampling bit of linear PCM audio
PCM CHANNEL	The number of channels of linear PCM audio
COMPRESSED AUDIO	Compressed audio supported or not.

## 9 Product specification

Item				Description	
Input	Video	HDMI / DVI	Number / Signal	2 inputs / HDMI Deep Color (*1) / DVI 1.0 - HDCP1.4 - TMDS single link - TMDS clock: 25 MHz to 225 MHz - Dot clock: 25 MHz to 165 MHz	
			Connector	2 female HDMI Type A	
			Others	Built-in Digital Cable EQ, EDID emulation	
		HDBaseT	Number / Signal	2 inputs / HDBaseT - HDCP1.4 (*2) - TMDS single link - TMDS clock: 25 MHz to 225 MHz - Dot clock: 25 MHz to 165 MHz	
	Connector		2 RJ-45 (*3) / Cable: Cat5e / Cat6 (STP/UTP straight cable) / CAT.5E HDC cable (*4)		
	Format		480i / 480p / 576i / 576p / 720p / 1080i / 1080p VGA to QWXGA * WUXGA / QWXGA are supported only with Reduced Blanking		
	Audio	Digital	Number / Signal	4 inputs / Multi-channel linear PCM up to 8 channels - Sampling frequency: 32 kHz to 192 kHz - Sample bit: 16 bit to 24 bit - Reference level:-20 dBFS - Max. input level: 0 dBFS * IN1 to IN3 are switch-selectable between digital and analog audio	
			Connector	2 female HDMI Type A 2 RJ-45 (*3)	
	Output	Video	HDMI / DVI	Number / Signal	1 output / HDMI Deep Color (*1) / DVI 1.0 - HDCP1.4 - TMDS single link - TMDS clock: 25 MHz to 225 MHz - Dot clock: 25 MHz to 165 MHz
				Connector	1 female HDMI Type A
HDBaseT			Number / Signal	1 output / HDBaseT - HDCP1.4 (*2) - TMDS single link - TMDS clock: 25 MHz to 225 MHz - Dot clock: 25 MHz to 165 MHz y	
			Connector	1 RJ-45 (*3) / Cable: Cat5e / Cat6 (STP/UTP straight cable) / CAT.5E HDC cable (*4)	
Format		480i / 480p / 576i / 576p / 720p / 1080i / 1080p VGA / SVGA / XGA / WXGA (1280 x 768) / WXGA (1280 x 800) / Quad-VGA / SXGA / WXGA (1360 x 768) / WXGA (1366 x 768) / SXGA+ / WXGA+ / WXGA++ / UXGA / WSXGA+ / VESA1080 / WUXGA / QWXGA * VESA1080 / WUXGA / QWXGA are only output as Reduced Blanking			
Audio		Digital	Number / Signal	2 output / Multi-channel linear PCM up to 8 channels	

				- Sampling frequency: 32 kHz to 192 kHz - Sample bit: 16 bit to 24 bit - Reference level: -20 dBFS - Max. output level: 0 dBFS
			Connector	1 female HDMI Type A, 1 RJ-45
			Number / Signal	1 output / Stereo LR balanced and unbalanced signals - Balanced signal Output impedance: 100 Ω Reference level: -4 dBu Max. output level: +16 dBu - Unbalanced signal Output impedance: 50 Ω Reference level: -10 dBu Max. output level: +10 dBu
			Connector	2 terminal blocks (5-pin)
Max. extension distance	Input	HDMI / DVI	From 32.8 ft/10 m up to 99 ft/30 m (approx.) (*5)	
		HDBaseT	Max. 330 ft/100 m (approx.) (*6)	
	Output	HDMI / DVI	Max. 16.4 ft/5 m (approx.) (*5)	
		HDBaseT	Max. 330 ft/100 m (approx.) (*6)	
Function	Scan Converter	Aspect Ratio Control, Seamless Switching (*7), Picture adjustment (brightness, contrast, display position, display size), Picture-in picture (PiP)		
	Others	All function settings through browser Volume adjustment (volume of input and output ports can be set separately) Cross-point memory (storage for 4 settings ) Preset memory (8 settings and startup settings) Last memory Anti-Snow (*8) Connection Reset (*9) Front panel security lockout Auto input detection and switching		
External control	Serial control port	Number / Signal	1 port / RS-232C	
		Connector	1 terminal block (3-pin)	
	LAN control port	Number / Signal	1 port / 10Base-T (Auto Negotiation), 100Base-TX (Auto Negotiation), Auto MDI/MDI-X	
		Connector	1 RJ-45	
Others	Power	Input: 100 - 240 VAC ± 10%, 50 Hz / 60 Hz ± 3 Hz Output: 12 VDC 3 A (power supply unit is supplied)		
	Power consumption	About 29 Watts		
	Dimensions	8.27 x 1.73 x 9.84"/ 210 (W) x 44 (H) x 250 (D) mm (EIA rack 1/2U size, not including projections)		
	Weight	4.19 lbs. approx. / 1.9 kg		
	Temperature	Operating: 32 °F to 104 °F / 0 °C to +40 °C Storage: -4 °F to +176 °F / -20 °C to +80 °C		
	Humidity	Operating / Storage humidity: 20% to 90% (Non Condensing)		

\*1 30 bit/pixel (10 bit/component) Deep Color is supported while xvYCC, Lip Sync, 3D, ARC and HEC are not supported.

\*2 Only HDBaseT output does not support HDCP-compliant DVI signals.

\*3 RJ-45 (HDBaseT connector) is only for Cat5e / Cat6 twisted pair cable. Please do not use it for LAN devices or the like.

\*4 T568A or T568B straight. For transmission longer than 164 ft. (50 m), Cat6 UTP/STP cable is recommended.

\*5 The extension distance depends on the connected I/O devices. The distance mentioned above is the maximum extension range acquired when IDK's AWG24 cable was used and signals of 1080p@60 24 bit / pixel (8 bit / component) was input or output. With some I/O combinations, and if you use cables of other manufacturer, video may be disturbed or may not be output even if signals are within the range mentioned above.

\*6 If connected to a device whose status is significantly bad, video signal can be unstable or cannot be output. Check the operation beforehand or contact us.

\*7 Seamless switching with a black frame.

\*8 The anti-snow feature automatically fixes snow noise that is a specific symptom of HDCP-compliant signals and mainly occurs at start-up. This feature does not work when snow noise has already occurred during startup or when it occurs due to a bad condition of the transmission line.

\*9 For digital systems, some problems, such as an HDCP authentication error, can often be recovered by physically disconnecting and reconnecting the digital cables. However, the Connection Reset feature will fix these problems automatically without the need to physically plug and unplug the cables. It creates the same condition as if the cable were physically disconnected and reconnected. This feature only works for the MSD's output. If other devices are connected between the MSD's output and sink device, this feature may be invalid.

## 10 Troubleshooting

This chapter recommends what to do if you have problems operating the MSD.

In case the MSD does not work correctly, please check the following items first.

- Are the MSD and all devices plugged in and powered on normally?
- Are cables connected correctly?
- Are there no loose connections?
- Are correct cables supported by devices being used?
- Are signal specifications of connected devices matched to each other?
- Are settings of the sink device correct?
- Are there any close objects that may cause noise?

If the problem still cannot be solved, perform the following actions. Refer to manuals of connected devices as well, since they may possibly be the cause of the problem.

Problem	Cause/Check item/Solution	Page
●Video output		
Video is not output.	<p>Check the error code in <b>"8.15.2 Sink device status (P.103)"</b>. (Since the MSD has multiple output connectors, check the error code of the output connector that does not output video.)</p> <ul style="list-style-type: none"> <li>· Error message: "Not DDC Power" Check if the source device is connected and turned on.</li> <li>· Error message: "No Signal" Signal is not input. Check [1] to [5] on the next page</li> <li>· Error message: "AV Mute Received" A problem may occur in the source device or HDCP authentication. Check [2], [4] and [5].</li> <li>· Error message: "HDCP Video Mute" With using a sink device that is not HDCP compliant, only video without content protection (such as analog input and test pattern) can be output, and go black if signal with content protection is input. Some source devices check whether the sink device is HDCP compliant or not and output video depending on the result. Since the MSD supports HDCP, output video cannot be output if the sink device is not HDCP compliant. In that case, you can disable HDCP input from the source device in <b>"8.6.2 Setting HDCP input (P.52)"</b> in order to display the video.</li> <li>· Error message: "Not AVInfoFrame" or "Dot Clock Over" A problem occurs in the source device.</li> <li>· Error message: "Channel OFF" Set <b>"7.2 Switching input channel (P.23)"</b> to a value other than "OFF".</li> </ul>	—

Problem	Cause/Check item/Solution	Page
Video is not output.	<ul style="list-style-type: none"> <li>• If no error code is displayed: Set "<b>8.4.11 Test pattern (P.45)</b>" to a pattern other than "OFF". If any test pattern is not output, check [4] to [6]. If a test pattern is output, the source device may not output video.</li> </ul>	—
Input video is not output.	[1] The set time for monitoring a no-signal input may be too short.	52
	[2] Change the settings of input equalizer (only for HDMI connector.)	53
	[3] If the source device has multiple output connectors, check the video output settings of the device.	—
Video is disappeared, interrupted, or has noise.	[4] If using a long cable for input or output, replace it with a 5 m/16.4 ft. or shorter cable. Since the MSD has the equalizing function, long cables can be connected, but the MSD may not provide its full performance depending on the cable quality and the connected device. If the problem is solved by replacing the cable, signal might have been degraded due to the long haul transmission. We have high-quality cables, cable boosters and extenders. Please contact us as needed. In case of HDBaseT input, twisted pair cable might be having external noise. Please check twisted pair cable.	19
	[5] When high-speed signal (high resolution: such as UXGA, WUXGA, 1080p; DEEP COLOR signals) are input or output, video may not be displayed or noise may appear depending on the cable quality and the connected device. If the problem occurs only when a specific input is selected, the problem was caused by the input side. If it occurs for all inputs or only when a test pattern is displayed, the problem was caused by the output side. Change the resolution to a lower level and/or disable Deep color. You can check the resolution and color depth of the input signal in " <b>8.15.1 Input signal status (P.100)</b> " and can limit resolution and color depth of input signal according to the EDID setting. You can also specify output resolution and check the color depth of the output signal in " <b>8.15.2 Sink device status (P.103)</b> " and limit the output signal color depth.	71, 72, 73 40 63
Input video and test pattern are not output.	[6] If you set the output resolution other than "AUTO", check if the selected resolution is supported by the sink device. If you select 480i, 576i, or 1080i, video may not be output to sink devices that do not support interlaced signal. For TV output resolutions (480i to 1080p), check the vertical synchronous frequency. PC output resolutions (VGA to QWXGA) may not be output to LCD TVs.	40
Video is interrupted.	If you set automatic detection of input video interruption to "ON", false detection may occur. Change the setting to "OFF".	53
Video is interrupted or has noise	If the problem occurs only with specific digital input, change settings of the input equalizer.	53

Problem	Cause/Check item/Solution	Page
Video from HDMI/DVI output is choppy or has noise.	If the problem occurs in all input channels or at the time of displaying a test pattern and a long cable is connected for output, then change the output equalizer setting.	—
Video from HDBaseT output is choppy or has noise.	If the problem occurs in all input channels or at the time of displaying a test pattern, the twisted pair cable may be affected by external noise. Check the twisted pair cable.	19
The left, right, top and bottom sides are cut off.	If the problem occurs only when "CROSS HATCH" (a test pattern) is output, the sink device enlarges and displays the video. Adjust the sink device. If the device does not have the adjusting function, set the video size and position of the output. If the problem occurs even if "CROSS HATCH" is output to all outputs, check [7] to [11].	45 43, 43
Part of video is cut off or black is displayed at edge(s).	[7] Check the overscan setting.	42
	[8] Settings of the display position or size are not changed? <b>Note:</b> Display position and size can be set for each input or output.	43, 43 38
	[9] If aspect ratios of the input signal and output resolution do not match, video may be cut off automatically or black may be displayed at edge(s) depending on settings. If the video is displayed on the full screen by setting the aspect ratio to "FULL", there is no problem. If the aspect ratios are not the same, you can select a) or b) below: a) video will be cut off b) black will be displayed at edge(s)	41 42
	[10] For digital input, start position and active area do not have to be set. Only when video edges are cut off 1 to 2 dots, set those items. (For digital input, the total number of horizontal dots cannot be set).	57, 58
Black appears at top, bottom, right and left on PC video or only part of the PC video is displayed, and the rest is displayed by scrolling with the mouse.	[11] Does the resolution setting for the PC (You can check it in "Properties" of the PC) and the resolution output from the PC (You can check it in "8.15.1 Input signal status (P.100)" match? If not, set the EDID and PC resolution. If the copy of the built-in LCD monitor in the laptop is output, the resolution of the LCD monitor is applied for outputting the video to the external monitor, and black bars may appear at edges. The problem can be solved by enlarging the display or displaying only to the external monitor.	70, 71
Video is reduced vertically or horizontally.	Does the selected aspect ratio of the output resolution and that of the connected sink device match? If not, set the aspect ratio of the sink device.	41
	Check the set aspect ratio of the input signal.	41
	Check the monitor setting of the source device (such as 4:3, 16:9, letter box and the like).	—
Video flickers.	Sometimes video flickers might happen when interlace and static video signal is input.	—
	If interlace signal is input to a sink device that does not support interlace signal, the video may blink. Check the output resolution of the sink device.	40
PC's dual monitor cannot be set or the setting is canceled.	If the monitoring function for no-signal input works, the dual monitor function may not operate correctly. In this case, turn the monitoring function "OFF".	52

Problem	Cause/Check item/Solution	Page
It takes a long time to output video after video input is switched.	If you set the HDCP output to "HDCP INPUT ONLY", some sink devices may fail HDCP authentication. In this case, it may temporarily not output video and audio when a channel signal without HDCP support is input and then is switched to a channel signal with HDCP support is input. In this case, set the HDCP output setting to "ALWAYS".	62
Part of the bitmap is cut off, or bitmap is not displayed on the full screen.	If the bitmap resolution and output resolution do not match, the bitmap may be partially cut off or may not be displayed on the full screen, depending on settings of the aspect ratio and display position. In this case, set the aspect ratio and display position as necessary.	91
<b>●PinP output</b>		
PinP output cannot be displayed.	Set " <b>7.2 Switching input channel (P.23)</b> " to other than "OFF", and set " <b>8.3.2 PinP output (P.35)</b> " to "ON".	—
	Settings of the display position or size are not changed?	43
<b>●Audio output</b>		
Audio is not output.	<p>If audio is not output, first check the error code in "<b>8.15.2 Sink device status (P.103)</b>". (The MSD has multiple output connectors. Find the error code of the output connector that does not output audio.)</p> <ul style="list-style-type: none"> <li>• Error message: "Audio Mute" Turn "<b>8.9.2 Output mute (P.66)</b>" to "OFF".</li> <li>• Error message: "Not DDC Power" Ensure that the source device is connected and turned on.</li> <li>• Error message: "No Signal" Signal is not input. Check [12], [13], and [15]</li> <li>• Error message: "AV Mute Received" There may be problems in the source device side or HDCP authentication. Check [12].</li> <li>• Error message: "HDCP Audio Mute" If the display device or AV amplifier does not support HDCP, only audio without content protection (such as analog input) is output; audio is not output when signal with content protection is input. Some HDMI/DVI devices will check if the connected device is HDCP compliant and determines whether to output HDCP signals or not. As the MSD is HDCP compliant, audio may not be output if the MSD is connected to a sink device or AV amplifier that does not support HDCP. In this case, disable HDCP input from the input device in "<b>8.6.2 Setting HDCP input (P.52)</b>".</li> <li>• Error message: "Not AUDInfoFrame" There are problems in the source device.</li> <li>• Error message: "Compressed Audio" LCD monitors may not output compressed audio, such as Dolby Digital, DTS, and so on. If playing contents with compressed audio (such as Blu-ray disc), check the audio output setting. Audio signal output from the source device can be controlled by setting EDID.</li> </ul>	73

Problem	Cause/Check item/Solution	Page
Audio is not output.	<ul style="list-style-type: none"> <li>• Error message: "Digital Out OFF" Turn "<b>8.9.3 Audio output connector (P.66)</b>" to other than "ANALOG".</li> <li>• Error message: "Analog Out OFF" Turn "<b>8.9.3 Audio output connector (P.66)</b>" to other than "DIGITAL"</li> <li>• Error message: "DVI Mode" Turn "<b>8.8.1 Output mode (P.60)</b>" to other than "DVI MODE". If the sink device does not support HDMI signal, the MSD outputs DVI signal automatically. Check which signal is supported by the sink device.</li> <li>• Error message: "Channel OFF" Turn "<b>7.2 Switching input channel (P.23)</b>" to a value of other than "OFF"</li> <li>• If any error code is not displayed: Check [12] to [15]. The source device may not be outputting audio.</li> </ul>	
Audio is not output.	[12] Is video being output correctly? If not, check [1], [2], [4] and [5].	—
	[13] Is DVI signal output from the source device? You can check the input signal type in " <b>8.15.1 Input signal status (P.100)</b> ". DVI signal may be output depending on EDID settings.	72
	[14] Is audio format being used supported by the connected sink device or AV amplifier input? LCD monitors, especially, may not output 88.2 kHz or more sampling frequency of linear PCM and compressed audio (such as Dolby Digital, DTS, and so on). Audio signal output from the source device can be controlled by setting EDID.	100 73
	[15] If the source device has multiple output connectors, check the audio output settings of the selected output device.	—
Audio is output from digital output connectors but not from analog output connectors.	If compressed audio (such as Dolby Digital, DTS, and so on) is input, analog audio is not output. You can check the input audio type in " <b>8.15.1 Input signal status (P.100)</b> ".	64 73
	Ensure that terminal block is connected and there is no wrong cabling.	20
Audio is output from analog output connectors but not from digital output connectors.	If the output resolution is set to a value other than "AUTO", make sure that the resolution that can be output from the sink device or AV amplifier is selected. If a PC output resolution (VGA to QWXGA) is selected, some sink devices and AV amplifiers cannot output audio.	40
Compressed audio (such as Dolby Digital, DTS) is not output from the source device.	Compressed audio input is controlled (EDID settings) by factory default. If using compressed audio, change the EDID setting.	73
	In order to output compressed audio of multi-channel, set the number of speakers.	74
	Check the audio output settings of the source device.	—



Problem	Cause/Check item/Solution	Page
Multi-channel audio is not output.	In order to output multi-channel audio, set the number of speakers.	74
Only audio of a specific scene is not output from digital input	Is "DOWN MIX" is set for multi-channel audio output? For multi-channel audio, since channels changes depending on scenes, audio may not output if audio is not included in the set channel.	67
<b>●Key operation</b>		
Keys do not operate.	Make sure that keys are not locked.	24
	Immediately after start-up, all keys are disabled until the connection of the sink device is completed.	23
<b>●WEB browser operation</b>		
WEB menu is not displayed.	Make sure that IP address which input to address bar matches the MSD IP address setting or not.	28
	Make sure that LAN setting of the MSD.	80
	Depending on the configuration, loop issue is happened.	79
Settings are not saved or reflected to the MSD.	Some WEB menu must press "SET" button to save or reflect setting to the MSD.	29
<b>●Communication command control</b>		
Communication command control from the PC to the MSD cannot be performed.	Are the following items set correctly? For RS-232C: baud rate and data length For LAN: IP address or subnet mask	79 80, 81
	The MSD cannot be controlled from HDC transmitter or receiver's RS-232C connectors.	76
	In case of RS-232C communication, please make sure terminal block is connected and there is no wrong cabling.	20
<b>●Others</b>		
Input signal temporarily disappear when input channel is switched.	When the CEC connection changes, EDID may change. In this case, input signal is interrupted. Check the connection settings.	63
Devices cannot be controlled through CEC.	Are HDMI cables supporting CEC being used?	63
	To use CEC, enable HDMI link control of the connected devices (such as LCD TVs, Blu-ray recorder, and so on).	

If additional assistance is required, please perform the following tests and then contact us.

1. The problem occurs at all connectors?
2. Connect the devices using genuine cables without connecting the MSD.

The problem still cannot be solved? Please contact us for assistance.

## User's guide of MSD-402

Ver.1.0.0

Issued on: 30 September 2016

---

---



**Headquarters** IDK Corporation  
7-9-1 Chuo, Yamato-shi, Kanagawa-pref.  
242-0021 JAPAN  
TEL: +81-46-200-0764 FAX: +81-46-200-0765  
Email: [idx\\_eng@idx.co.jp](mailto:idx_eng@idx.co.jp) URL: <http://www.idx.co.jp/en/index.html>

**USA** IDK America Inc.  
72 Grays Bridge Road Suite 1-C, Brookfield, CT 06804  
TEL: +1-203-204-2445  
Email: [sales@idxav.com](mailto:sales@idxav.com) URL: <http://www.idxav.com>

**Europe** IDK Europe GmbH  
Lise-Meitner-Str. 6, D-40878 Ratingen  
TEL: +49-2102-578-301-0  
Email: [info@idxav.eu](mailto:info@idxav.eu) URL: <http://www.idxav.eu>



**Product information** Arvanics Corporation  
**Support** 3-8-3-3F Yamato Higashi, Yamato-shi, Kanagawa-pref.  
242-0017 JAPAN  
TEL: +81-46-259-6920 FAX: +81-46-259-6930  
Email: [info@arvanics.com](mailto:info@arvanics.com) URL: <http://www.arvanics.com>

Information in this document is subject to change without notice.  
All rights reserved. All trademarks mentioned are the property of their respective owners.