

HDBaseT Extender

HDC-S01U-T/HDC-S01U-R

<User Guide>

Ver.1.0.0

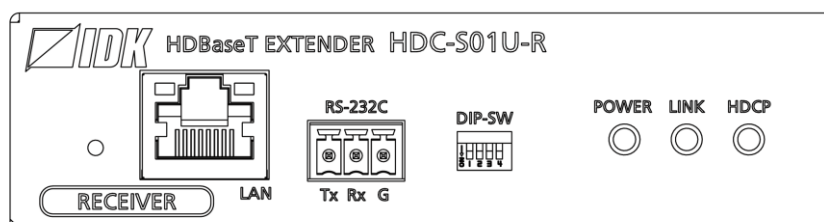
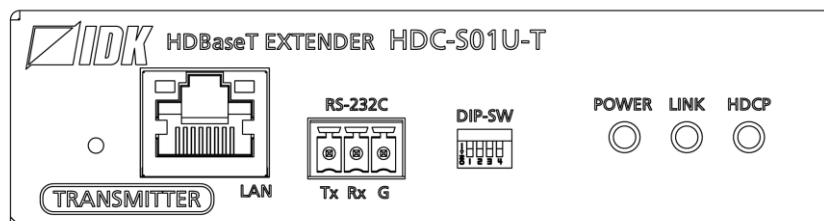

- Thank you for choosing our product.
- To ensure the best performance of this product, please read this user guide fully and carefully before using it and keep this manual together with the product for future reference as needed.

Trademarks

- Blu-ray Disc and Blu-ray are trademarks of Blu-ray Disc Association.
- ETHERNET is a registered trademark of Fuji Xerox Co., Ltd.
- HDBaseT™ and the HDBaseT Alliance Logo are trademarks of the HDBaseT Alliance.
- The terms HDMI and HDMI High-Definition Multimedia Interface, and the HDMI Logo are trademarks or registered trademarks of HDMI Licensing Administrator, Inc. in the United States and other countries.
- The terms Anti-snow and Connection Reset are registered trademarks of IDK Corporation in Japan.
- All other company and product names mentioned in this manual are either registered trademarks or trademarks of their respective owners. In this manual, the “®” or “™” marks may not be specified.

Before reading this manual

- All rights reserved.
- Some information contained in this user guide such as exact product appearance, diagrams, and so on may differ depending on the product version.
- This user guide is subject to change without notice. You can download the latest version from IDK's website at: www.idkav.com

FCC STATEMENT

This equipment has been tested and found to comply with the limits for a Class A digital device, pursuant to part 15 of the FCC Rules. These limits are designed to provide reasonable protection against harmful interference when the equipment is operated in a commercial environment. This equipment generates, uses, and can radiate radio frequency energy and, if not installed and used in accordance with the instruction manual, may cause harmful interference to radio communications. Operation of this equipment in a residential area is likely to cause harmful interference, in which case the user will be required to correct the interference at his own expense.

CE MARKING

This equipment complies with the essential requirements of the relevant European health, safety and environmental protection legislation.

WEEE MARKING











Waste Electrical and Electronic Equipment (WEEE), Directive 2002/96/EC
(This directive is only valid in the EU.)

This equipment complies with the WEEE Directive (2002/96/EC) marking requirement.
The left marking indicates that you must not discard this electrical/electronic equipment in domestic household waste.

Safety Instructions

Read and understand all safety and operating instructions before using this product. Follow all instructions and heed all warnings/cautions.

| Enforcement Symbol | Description |
|--|---|
|  Warning | Indicates the presence of a hazard that may result in death or serious personal injury if the warning is ignored or the product is handled incorrectly. |
|  Caution | Indicates the presence of a hazard that may cause minor personal injury or property damage if the caution is ignored or the product is handled incorrectly. |



| Symbol | Description | Example |
|--|--|--|
|  Caution | This symbol is intended to alert the user. (Warning and caution) |  Hot surfaces Caution |
|  Prohibited | This symbol is intended to prohibit the user from specified actions. |  Do not disassemble |
|  Instruction | This symbol is intended to instruct the user. |  Unplug |

Warning





■ For lifting heavy products:

| | |
|---|--|
|  Instruction | <ul style="list-style-type: none"> ● Lifting must be done by two or more personnel. <p>To avoid injury: When lifting the product, bend your knees, keep your back straight and get close to it with two or more persons.</p> |
|---|--|

■ For installing and connecting products:

| | |
|---|--|
|  Prohibited | <ul style="list-style-type: none"> ● Do not place the product upon a surface that may give way or that may become unstable. <p>Install the product in a secure and stable place to prevent it from falling and possibly causing injury.</p> <ul style="list-style-type: none"> ● Secure the product if installing in locations prone to vibration or movement. <p>Otherwise, it may move unexpectedly or it may fall and lead to injury.</p> |
|  Instruction | <ul style="list-style-type: none"> ● Installation work must be performed by professionals. <p>The product is intended to be installed by skilled technicians. For installation, please contact a system integrator or IDK. Improper installation may lead to the risk of fire, electric shock, injury, or property damage.</p> <ul style="list-style-type: none"> ● Insert the power plug into an outlet that is unobstructed. <p>Unobstructed access to the plug enables unplugging the product in case of any extraordinary failure, abnormal situation or for easy disconnection during extended periods of non-use.</p> <ul style="list-style-type: none"> ● Insert the power plug into an appropriate outlet completely. <p>If the plug is partially inserted, arcing may cause the connection to overheat, increasing the risk of electrical shock or fire. Do not use a damaged plug or connect to a damaged outlet.</p> <ul style="list-style-type: none"> ● Unplug the product from the AC power source during installation or service. <p>When connecting peripheral devices to this product, unplug all involved devices from outlets. Ground potential differences may cause fire or other difficulties.</p> |

■ For operating products:

| | |
|--|--|
|  Prohibited | <ul style="list-style-type: none"> ● Keep out any foreign objects. <p>To avoid fire or electric shock, do not permit foreign objects, such as metal and paper, to enter the product from vent holes or other apertures.</p> <ul style="list-style-type: none"> ● For power cable/plug: <ul style="list-style-type: none"> ▪ Do not scratch, heat, or modify, including splicing or lengthening them. ▪ Do not pull, place heavy objects on them, or pinch them. ▪ Do not bend, twist, tie or clamp them together forcefully. <p>Misuse of the power cable and plug may cause fire or electric shock. If power cables/plugs become damaged, contact your IDK representative.</p> |
|  Do not disassemble | <ul style="list-style-type: none"> ● Do not repair, modify or disassemble. <p>Since the product includes circuitry that uses potentially lethal, high voltage levels, disassembly by unauthorized personnel may lead to the risk of fire or electric shock. For internal inspection or repair, contact your IDK representative.</p> |
|  Do not touch | <ul style="list-style-type: none"> ● Do not touch the product and connected cables during electrical storms. <p>Contact may cause electric shock.</p> |
|  Instruction | <ul style="list-style-type: none"> ● Clean the power plug regularly. <p>If the plug is covered in dust, it may increase the risk of fire.</p> <ul style="list-style-type: none"> ● The product must be earthed. <p>To reduce the risk of electrical shock, ensure the product is connected to a mains socket outlet with a protective earthing connection.</p> |



■ **If the following problem occurs:**

| | |
|--|---|
|  Unplug | <ul style="list-style-type: none"> ● Unplug immediately if the product smokes, makes unusual noise, or produces a burning odor. If you continue to use the product under these conditions, it may cause electric shock or fire. ● Unplug immediately if the product is damaged by falling or having been dropped. If you continue to use the product under these conditions, it may increase the risk of electrical shock or fire. For maintenance and repair, contact your IDK representative. ● Unplug immediately if water or other objects are directed inside. If you continue to use the product under these conditions, it may increase the risk of electrical shock or fire. For maintenance and repair, contact your IDK representative. |
|--|---|



Caution

■ **For installing and connecting products:**

| | |
|--|--|
|  Prohibited | <ul style="list-style-type: none"> ● Do not place the product in a location where it will be subjected to high temperatures. If the product is subjected to direct sunlight or high temperatures while under operation, it may affect the product's performance and reliability and may increase the risk of fire. ● Do not store or operate the product in dusty, oil smoke filled, or humid place. If the product is placed near humidifiers or in a dusty area, it may increase the risk of fire or electric shock. ● Do not block the vent holes. If ventilation slots are blocked, it may cause the product to overheat, affecting performance and reliability and may increase the risk of fire. ● Do not place or stack heavy items on the product. Failure to observe this precaution may result in damage to the product and other property and may lead to the risk of personal injury. ● Do not exceed ratings of outlet and wiring devices. Exceeding the rating of an outlet may increase the risk of fire and electric shock. |
|  No wet hands | <ul style="list-style-type: none"> ● Do not handle power plug with wet hands. Failure to observe this precaution may increase the risk of electrical shock. |
|  Instruction | <ul style="list-style-type: none"> ● Use and store the product within the specified temperature/humidity range. If the product is used outside the specified range for temperature and humidity continuously, it may increase the risk of fire or electric shock. ● Do not place the product at elevations of 1.24 mi. (2,000 m) or higher above sea level. Failure to do so may shorten the life of the internal parts and result in malfunctions. ● When mounting the product into the rack, provide sufficient cooling space. Mount the product in a rack meeting EIA standards, and maintain spaces above and below for air circulation. For your safety as required, attach an L-shaped bracket in addition to the panel mount bracket kit to improve mechanical stability. ● Never insert screws without the rubber feet into the threaded holes on the bottom of the product. Never insert screws without the rubber feet into the threaded holes on the bottom of the product. Doing so may lead to damage when the screws contact electrical circuitry or components inside the product. Reinstall the originally supplied rubber feet using only the originally supplied screws. |

■ For operating products:





| | |
|--|--|
|  <p>Hot surfaces Caution</p> | <p>For products with the hot surfaces caution label only:</p> <ul style="list-style-type: none"> ● Do not touch the product's hot surface. <p>If the product is installed without enough space, it may cause failures of other products operation. If you touch product's hot surface, it may cause burn.</p> |
|  <p>Prohibited</p> | <ul style="list-style-type: none"> ● Use only the supplied power cable and AC adapter. ● Do not use the supplied power cable and AC adapter with other products. <p>If non-compliant adapter or power cables are used, it may increase the risk of fire or electrical shock.</p> |
|  <p>Unplug</p> | <ul style="list-style-type: none"> ● If the product won't be used for an extended period of time, unplug it. <p>Failure to observe this precaution may increase the risk of fire.</p> <ul style="list-style-type: none"> ● Unplug the product before cleaning. <p>To prevent electric shock.</p> |
|  <p>Instruction</p> | <ul style="list-style-type: none"> ● If cooling fan stops, power off the product and contact us. <p>Failure to do so may rise internal temperature and increase the risk of malfunction, fire, or electric shock.</p> <ul style="list-style-type: none"> ● Keep vents clear of dust. <p>If the vent holes near the cooling fan or near the fan are covered with dust, internal temperature rises and it may increase the risk of malfunction. Clean the vent holes and near the fan as needed.</p> <p>If dust accumulates inside of the product, it may increase the risk of malfunction, fire, or electric shock. Periodic internal cleaning, especially before humid rainy season, is recommended. For internal cleaning, contact your IDK representative.</p> |

Table of Contents

| | | |
|------|---|----|
| 1 | Included Items..... | 9 |
| 2 | About HDC-S | 10 |
| 3 | Features..... | 11 |
| 4 | Panels | 13 |
| 4.1 | HDC-S01U-T (Transmitter)..... | 13 |
| 4.2 | HDC-S01U-R (Receiver) | 14 |
| 5 | Precautions | 15 |
| 5.1 | Installation..... | 15 |
| 5.2 | Rack mounting hardware..... | 15 |
| 5.3 | Connection details | 16 |
| 5.4 | HDMI cable | 16 |
| 5.5 | Securing HDMI cable..... | 17 |
| 5.6 | Category cable..... | 18 |
| 5.7 | LAN cable | 19 |
| 5.8 | RS-232C cable..... | 20 |
| 5.9 | RS-232C communication function | 20 |
| 5.10 | AC adapter with screw locking mechanism | 21 |
| 6 | Product specification..... | 22 |
| 7 | Troubleshooting | 23 |

1 Included Items

Ensure that all items below are included in the package.

If any items are missing or damaged, please contact IDK.

■ Transmitter

- HDC-S01U-T x1
- AC adapter with screw locking mechanism (6 ft. (1.8 m)) x1
- Cable clamp x2
- 3-pin captive screw connector x1

■ Receiver

- HDC-S01U-R x1
- AC adapter with screw locking mechanism (6 ft. (1.8 m)) x1
- Cable clamp x1
- 3-pin captive screw connector x1

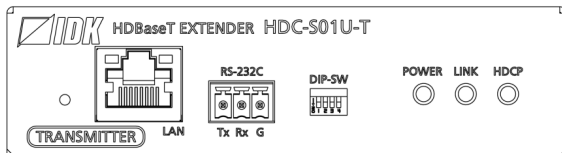

HDC-S01U-T (Transmitter) main unit

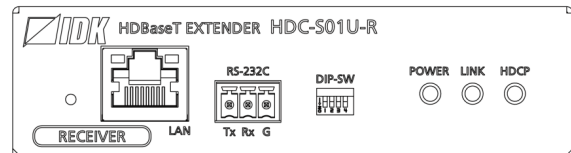

HDC-S01U-R (Receiver) main unit

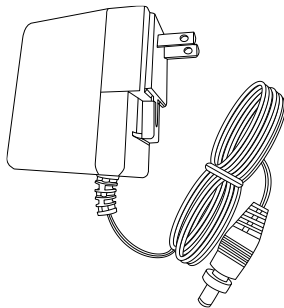

AC adapter with screw locking mechanism (6 ft. (1.8 m))

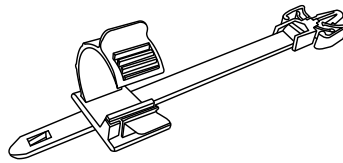

Cable clamp

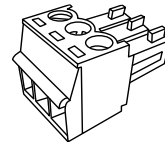

3-pin captive screw connector

2 About HDC-S

The HDC-S01U-T/R (hereafter referred to as “HDC-S”) is an HDBaseT transmitter and receiver set for sending HDMI signals up to 328 ft. (100 m) over a Category (CAT) cable without compression or processing. The HDC-S01U-T/R supports video signals at resolutions up to 4K@60 (4:4:4) and is HDCP 2.2 compliant. HDBaseT signal is encrypted robustly by copyright protection technology. Integrator-friendly features include bidirectional RS-232C and LAN communication allowing control commands and status to be sent and monitored. Additionally, the HDC-S01U-T includes a local HDMI output connector for real-time video monitoring.

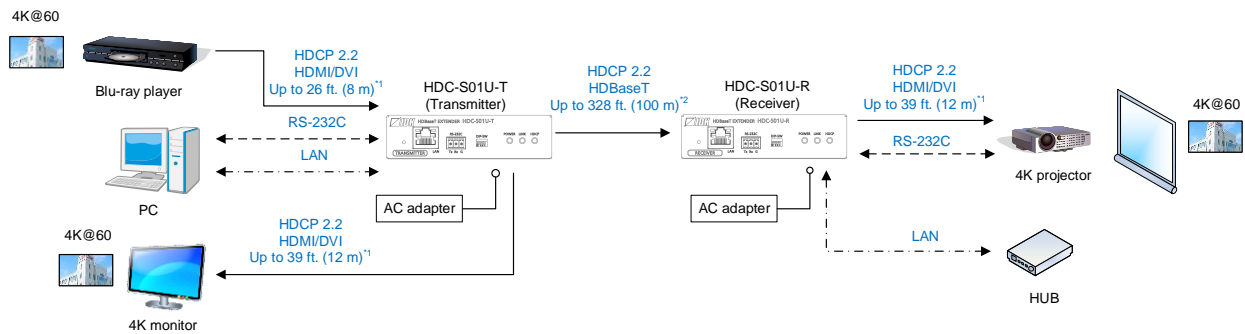

¹ Maximum transmission distances
 26 ft. (8 m), 39 ft. (12 m) : 4K@60 (4:4:4) (when cable supporting 18 Gbps transmission is used)
 66 ft. (20 m) : 1080p@60

² Maximum transmission distance
 328 ft. (100 m) : 4K@60 (4:4:4) (when CAT6A (U/FTP) cable is used)

Notes:

- Use the transmitter and receiver together.
- When the transmitter is powered ON, the EDID of a sink device that is connected to the transmitter has a priority. If no sink device is connected to the transmitter, the EDID of a sink device that is connected to the receiver has a priority. This conveys a problem that video may not be displayed if the supported resolutions of the connected sink devices are not the same. Connection having a priority is kept unless the HDC-S is powered ON/OFF or cable is plugged/unplugged.
- If HDMI output of the receiver is interrupted (receiver turned ON/OFF, cable plugged/unplugged, HDBaseT signal distorted, or the like), HDMI output video of the transmitter (local monitor output) may not be displayed temporarily.
- CEC control from a source device to a sink device is not supported. Control from a sink device to a source device for sink devices that are connected the transmitter/receiver is supported. To enable the CEC control, set the HDMI link function in the sink device side.
- Long reach mode is not supported.

3 Features

■ Video

- Up to 4K@60 (4:4:4)
- HDCP 1.4/2.2
- HDR
- 3D
- x.v.Color
- Maximum extension distance of category cable for HDBaseT
 - 328 ft. (100 m): 4K@60 (4:4:4) (when CAT6A (U/FTP) cable is used)
- HDMI Transmission distances:
 - Up to 39 ft. (12 m): 4K@60 (4:4:4) (when cable supporting 18 Gbps transmission is used)
 - Up to 66 ft. (20 m): 1080p@60
- No virtual delay (10 μ s or less/328 ft. (100 m))

■ Communication

- Bidirectional RS-232C (up to 115.2 kbps)
- LAN (10Base-T/100Base-TX/1000Base-T (Auto Negotiation), Auto MDI/MDI-X)

■ Others

- DDC buffer
- Connection Reset pass-through
- AC adapter with screw locking mechanism

■ **HDC-S01U-T diagram**

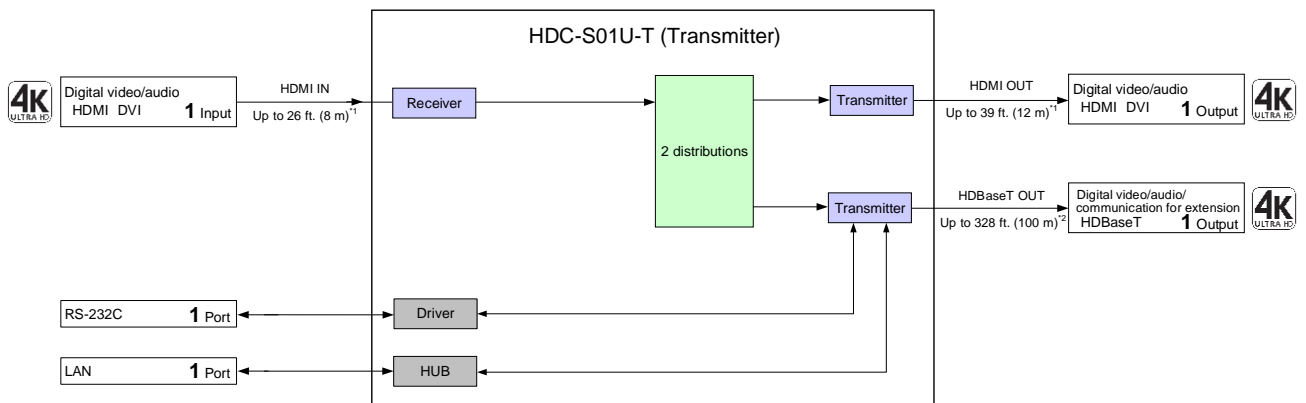

¹ Maximum transmission distances
 26 ft. (8 m), 39 ft. (12 m) : 4K@60 (4:4:4) (when cable supporting 18 Gbps transmission is used)
 66 ft. (20 m) : 1080p@60

² Maximum transmission distance
 328 ft. (100 m) : 4K@60 (4:4:4) (when CAT6A (U/FTP) cable is used)

■ **HDC-S01U-R diagram**

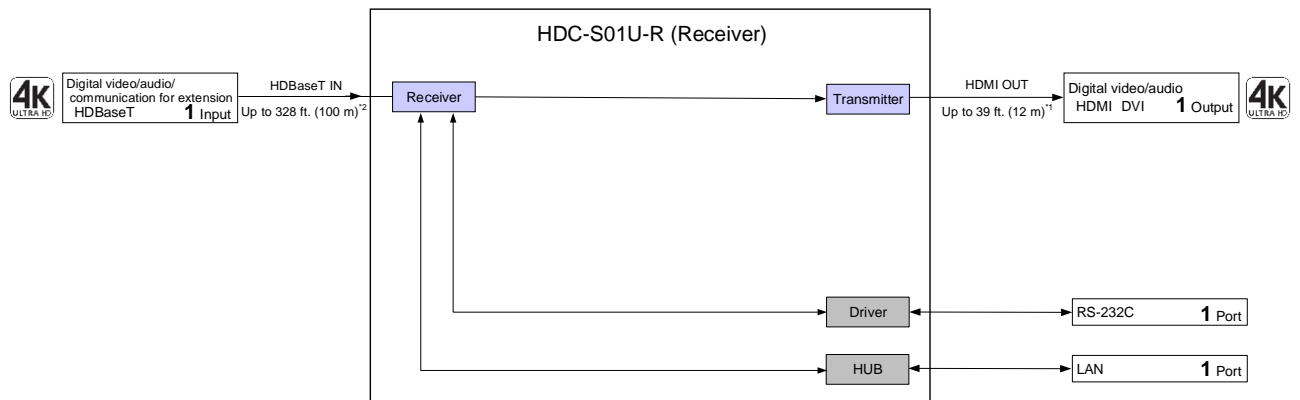

¹ Maximum transmission distances
 39 ft. (12 m) : 4K@60 (4:4:4) (when cable supporting 18 Gbps transmission is used)
 66 ft. (20 m) : 1080p@60

² Maximum transmission distance
 328 ft. (100 m) : 4K@60 (4:4:4) (when CAT6A (U/FTP) cable is used)

4 Panels

4.1 HDC-S01U-T (Transmitter)

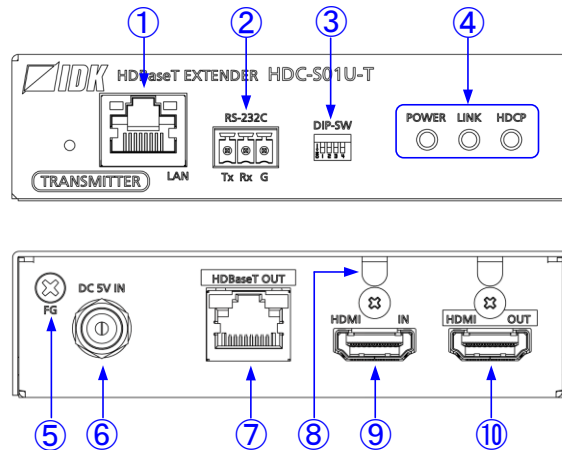

| # | Feature | Description |
|---|--------------------------|---|
| ① | LAN connector | Connector for LAN communication |
| ② | RS-232C connector | Connector for RS-232C serial communication |
| ③ | DIP switch | Do not use this connector (always OFF). |
| ④ | LED indicators | <p>POWER : Illuminates when power is supplied from the AC adapter.</p> <p>LINK : Illuminates when the receiver is connected. Does not illuminate when no connection.</p> <p>HDCP : Illuminates when video signal with HDCP is input. Blinks when video signal without HDCP is input. Does not illuminate when any input signals are not recognized.</p> |
| ⑤ | Frame ground | Use for bonding chassis to local ground. An M3 screw is used. |
| ⑥ | Power supply connector | For use with supplied AC adapter with screw locking mechanism |
| ⑦ | HDBaseT output connector | Output connector for HDBaseT signal Connects to the receiver. |
| ⑧ | HDMI cable fixing holes | Retain HDMI cables by inserting cable clamps. |
| ⑨ | HDMI input connector | Input connector for HDMI and DVI signals to interface source devices, such as Blu-ray player and PC |
| ⑩ | HDMI output connector | Output connector for HDMI and DVI signals Video that is being transmitted is displayed. |

4.2 HDC-S01U-R (Receiver)

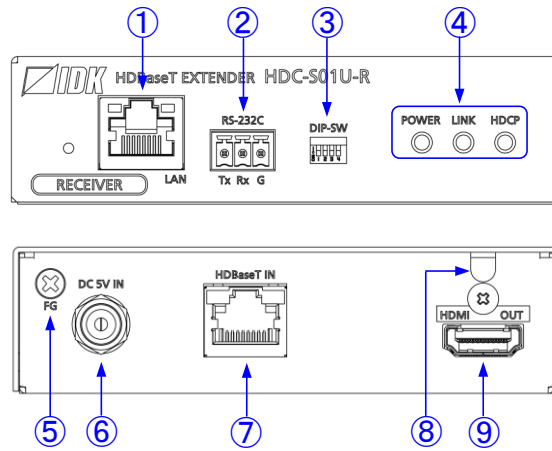

| # | Feature | Description |
|---|-------------------------|---|
| ① | LAN connector | Connector for LAN communication |
| ② | RS-232C connector | Connector for RS-232C serial communication |
| ③ | DIP switch | Do not use this connector (always OFF). |
| ④ | LED indicators | <p>POWER : Illuminates when power is supplied from the AC adapter.</p> <p>LINK : Illuminates when the transmitter is connected. Does not illuminate when no connection.</p> <p>HDCP : Illuminates when video signal with HDCP is output. Blinks when video signal without HDCP is output. Does not illuminate when any output signals are not recognized.</p> |
| ⑤ | Frame ground | Use for bonding chassis to local ground. An M3 screw is used. |
| ⑥ | Power supply connector | For use with supplied AC adapter with screw locking mechanism |
| ⑦ | HDBaseT input connector | Input connector for HDBaseT signal Connects to transmitter. |
| ⑧ | HDMI cable fixing hole | Retain HDMI cable by inserting cable clamp. |
| ⑨ | HDMI output connector | Output connector for HDMI and DVI signals, interface sink devices such as LC monitors and projectors |

5 Precautions

Before connecting to external devices, follow the precautions below.

5.1 Installation

When installing the HDC-S, please observe the following precautions.

- Do not stack or place one HDC-S directly on top of another HDC-S.
- Do not block vent holes.
- To provide adequate ventilation, maintain sufficient clearances around the HDC-S (1.2 in. (30 mm) or more).
- Consider installing the HDC-S in an environment compatible with the maximum temperature indicated in the specification sheet 32°F to 104°F (0°C to +40°C).

Maintain adequate clearances (1.2 in. (30 mm) or more) as shown below.

Bad example

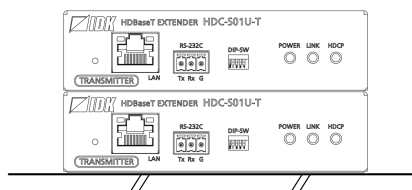

Good example

Good example

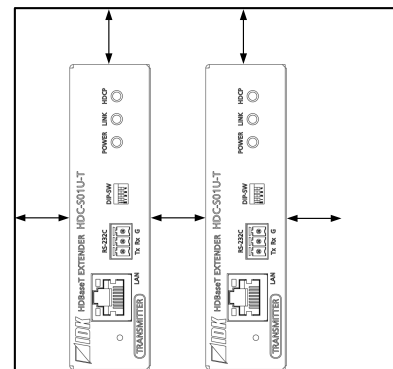
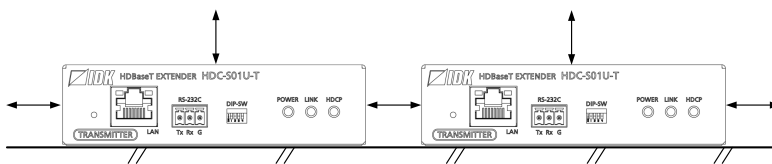

5.2 Rack mounting hardware

- Installing on wall or ceiling
You can install the HDC-S on a wall or ceiling using the optional mounting plate (FP-100).
- For installing the HDC-S in an EIA rack
We offer optional rack mounting hardware. Please contact us as needed.

5.3 Connection details

When connecting the HDC-S to external devices, observe the following precautions.

- Read manuals for the external devices.
- Before connecting cables to the HDC-S or an external device, dissipate static electricity by touching grounded metal such as equipment racks before handling signal cables. Failure to observe this precaution may result in ESD (electrostatic discharge) damage.
- Power all units off before connecting cables.
- Be sure to fully seat all plugs and connections and dress cables to reduce stress on connectors.

5.4 HDMI cable

When the video is 4K format, the maximum TMDS data rate (transmission speed) is 18 Gbps. If a high-speed HDMI cable is used, the maximum TMDS data rate of 10.2 Gbps can be transferred, and the video cannot be displayed stably.

Please select an 18 Gbps high-speed cable depending on the 4K format. The maximum transmission distance depends on the cable type, source and sink devices. You are recommended to use high quality cables.

| | TMDS data rate (Gbps) | | | | | | | | |
|--------------------------|-----------------------|------------|------------|--------------|--------------|--------------|--------------|------------|------------|
| | RGB, YCbCr 4:4:4 | | | YCbCr 4:2:2 | | | YCbCr 4:2:0 | | |
| 4K format | 24 bit | 30 bit | 36 bit | 24 bit | 30 bit | 36 bit | 24 bit | 30 bit | 36 bit |
| 3840x2160p (24/25/30) | 10.2 Gbps | 18 Gbps | 18 Gbps | 10.2 Gbps | 10.2 Gbps | 10.2 Gbps | N/A | N/A | N/A |
| 4096x2160 (24/25/30) | 10.2 Gbps | 18 Gbps | 18 Gbps | 10.2 Gbps | 10.2 Gbps | 10.2 Gbps | N/A | N/A | N/A |
| 3840x2160p (50/59.94/60) | 18 Gbps | N/A | N/A | 18 Gbps | 18 Gbps | 18 Gbps | 10.2 Gbps | 18 Gbps | 18 Gbps |
| 4096x2160 (50/59.94/60) | 18 Gbps | N/A | N/A | 18 Gbps | 18 Gbps | 18 Gbps | 10.2 Gbps | 18 Gbps | 18 Gbps |

18 Gbps: 18 Gbps high-speed cable; 10.2 Gbps: 10.2 Gbps cable

Note:

If a cable is extended and a cable joint is used, video may be interrupted or may not be output.

5.5 Securing HDMI cable

Secure HDMI cables using cable clamps to prevent connectors from being accidentally pulled out of ports.

Securing HDMI cable using cable clamp

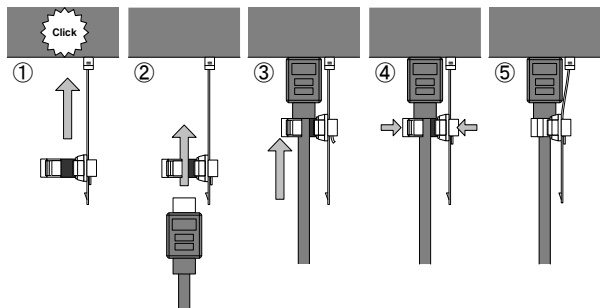

Removing HDMI cable and cable clamp

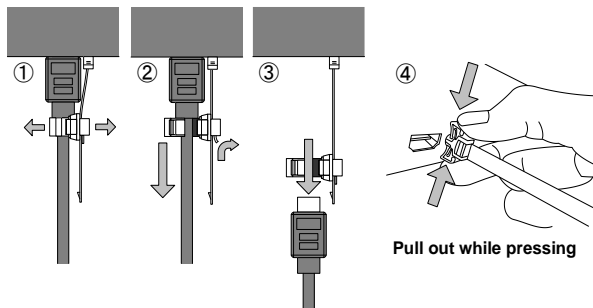

5.6 Category cable

To ensure the best performance with category cables, select a high quality category cable type, ensuring that proper pinning and pairing requirements are observed.

- CAT5E, CAT6, CAT6A, and CAT7 UTP/STP can be used, but we recommend CAT6A (U/FTP).
- There are various types of STP cable. Ensure that the selected STP is suitable.
- If signals are transmitted for a long haul or with noised from other devices, use a broadband cable or cable having high shielding performance. Note that specified distances may shorten depending on the conditions within the actual environment.

| Noise influence | General name | Category | Type | Transmission distance | Resolution |
|-----------------|--------------|-------------|--------|-----------------------|------------|
| Less affected | STP cable | CAT.5E HDC* | SF/UTP | 230 ft. (70 m) | 4K format |
| | | CAT6A | U/FTP | 328 ft. (100 m) | |

U: Unshielded, F: Foil shielded, S: Braid shielded, TP: Twisted Pair cable

*CAT.5E HDC cable is manufactured by IDK.

- If using STP cables, connect the FG connector to a local electrical ground bonding point. Without bonding FG to ground, the shielding feature may not effectively eliminate interference. If using UTP cables, it is still recommended that the FG connector be used.
- The STP cables are less affected by interference or external noise than UTP cables.
- Connectors for long-haul transmission are the same as that of eight-core modular connector used for Ethernet, but the transmission system is not the same so that it cannot be connected to Ethernet.
- Pin assignments: T568A or T568B straight
- Do not pull the cable using excessive force.
- Do not bend the cable at a sharp angle. Keep the bend radius four times of the cable diameter or larger.
- Do not clamp or tie the cable tightly; leave some space allowing the cable to move slightly.
- If you use multiple category cables, keep a distance between the cables or not to place the cables closely in parallel.
- Keep the category cable running as straight as possible. Looping or coiling the cable, causes it to be more easily affected by noise; especially when using longer cable run lengths.
- Do not place the cable in an electrically noisy environment, since high-speed impulsive noise may couple into the category cable. Use of a high-output radio transmission device near the HDC-S or remote receivers may interfere with or interrupt video and or audio signals.
- If the total transmission distance from the transmitter to receiver is 328 ft. (100 m) or less, up to two cable interconnection points can be used. Cable joint supporting Cat6A (10GBase-T) are recommended. For cable joint, use a cable joint for CAT6A (10GBase-T) or higher cable. For high resolution, video transmission distance may be shortened by about 10%.

5.7 LAN cable

Pin assignment of the LAN connector is as follows.

Communication speed is 10Base-T / 100Base-TX / 1000Base-T (Auto Negotiation), and Auto MDI/MDI-X is supported.

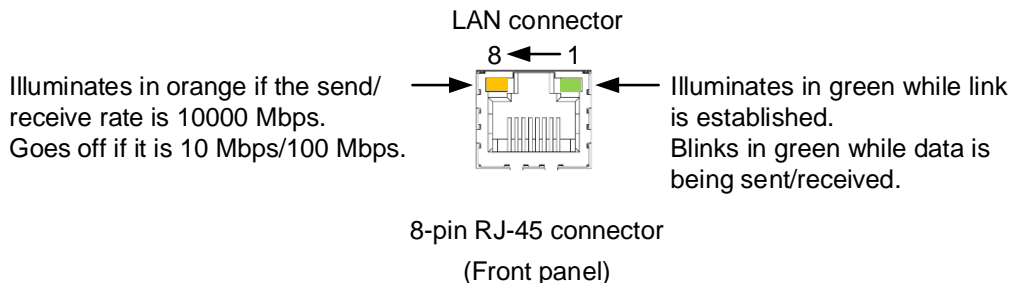

| RJ-45 pin# | Signal name | | | |
|------------|--------------------------|--|--------------------------|--|
| | MDI | | MDI-X | |
| | 1000Base-T ^{*1} | 10Base-T ^{*2} 100Base-TX ^{*2} | 1000Base-T ^{*1} | 10Base-T ^{*2} 100Base-TX ^{*2} |
| 1 | BI_DA+ | TD+ | BI_DB+ | RD+ |
| 2 | BI_DA- | TD- | BI_DB- | RD- |
| 3 | BI_DB+ | RD+ | BI_DA+ | TD+ |
| 4 | BI_DC+ | Unused | BI_DD+ | Unused |
| 5 | BI_DC- | Unused | BI_DD- | Unused |
| 6 | BI_DB- | RD- | BI_DA- | TD- |
| 7 | BI_DD+ | Unused | BI_DC+ | Unused |
| 8 | BI_DD- | Unused | BI_DC- | Unused |

^{*1} 1000Base-T: Bidirectional communication for all 8 pins.

^{*2} For 10Base-T and 100Base-TX, separate signal lines are used for transmitting (TD) and receiving (RD).

Note:

LAN connectors of the transmitter and receiver are connected as network. If both LAN connectors are connected to the same network, communication problem occurs due to loop connection.

5.8 RS-232C cable

The maximum communication speed is 115.2 kbps.

Insert and secure the wires from the RS-232C cable into the supplied 3-pin captive screw connector, and then insert the captive screw connector into the mating connector on the HDC-S.

28 AWG to 16 AWG conductor gauge is recommended.

The recommended wire strip length is 0.28 in. (7 mm).

Short RTS/CTS and DTR/DSR as needed.

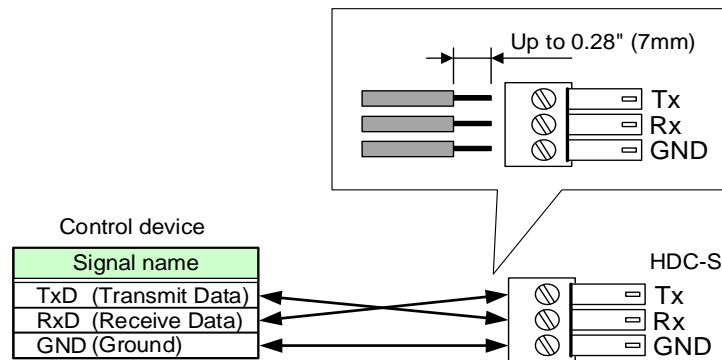

5.9 RS-232C communication function

When the HDC-S is powered ON, RS-232C communication is not available until the link between the HDC-S and connected devices are established. When the HDC-S is powered OFF, unintended data may be output. Special consideration would be needed for designing control program.

5.10 AC adapter with screw locking mechanism

The shapes of AC plugs with screw locking mechanism vary from country to country. The AC plug can be removed from the AC adapter.

Removing AC plug:

Slide the AC plug (②) from the AC adapter while holding down the portion mentioned below (①).

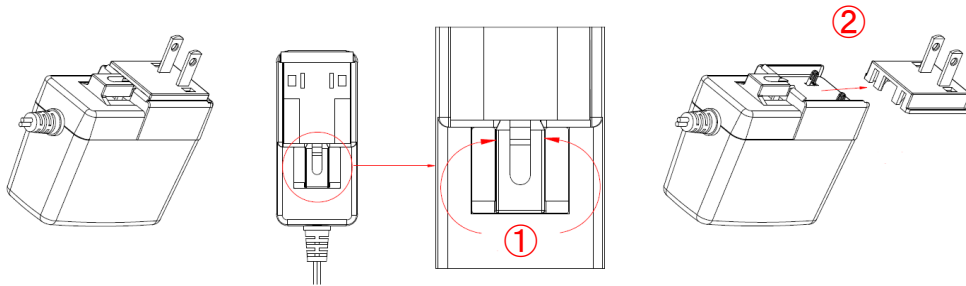

Attaching AC plug:

Gently slide the AC plug into the AC adapter (③) until it clicks (④).

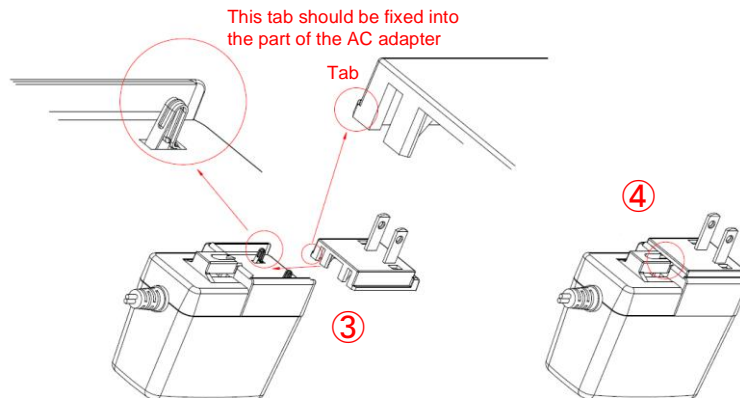

6 Product specification

| Item | | HDC-S01U-T (Transmitter) (*1) | HDC-S01U-R (Receiver) (*1) |
|--------------------------------|-------------------|--|---|
| Input | | 1 input HDMI/DVI 1.0 TMDS single link, HDCP 1.4/2.2 x.v.Color/3D/HDR/CEC (*2) Connector: 1 female HDMI Type A (19-pin) | 1 input HDBaseT HDCP 1.4/2.2 x.v.Color/3D/HDR/CEC (*2)/RS-232C/LAN Connector: 1 RJ-45 (*3) |
| Output | | 1 output HDBaseT HDCP 1.4/2.2 x.v.Color/3D/HDR/CEC (*2)/RS-232C/LAN Connector: 1 RJ-45 (*3) | 1 output HDMI/DVI 1.0 TMDS single link, HDCP 1.4/2.2 x.v.Color/3D/HDR/CEC (*2) Connector: 1 female HDMI Type A (19-pin) |
| | | 1 output HDMI/DVI 1.0 TMDS single link, HDCP 1.4/2.2 x.v.Color/3D/HDR/CEC (*2) Connector: 1 female HDMI Type A (19-pin) | |
| Format | | VGA to 4K 480i / 480p / 576i / 576p / 720p / 1080i / 1080p / 4K For 4K formats, 24 Hz/25 Hz/30 Hz/50 Hz (4:4:4)/60 Hz (4:4:4) are supported. | |
| Color depth | | 24 bit, 30 bit, 36 bit Deep Color For 4K@50/59.94/60 RGB/YCbCr 4:4:4, 24 bit is supported. | |
| Dot clock | | 25 MHz to 600 MHz | |
| TMDS clock | | 25 MHz to 340 MHz | |
| TMDS data rate | | 0.75 Gbps to 18 Gbps | |
| Digital audio (Input/Output) | | Multi-channel LPCM up to 8 channels Sampling frequency: 32 kHz to 192 kHz Sample size: 16 bit to 24 bit | |
| Maximum transmission distances | Digital input | HDMI/DVI : 66 ft. (20 m) (1080p@60), 26 ft. (8 m) (4K@60) (*4) HDBaseT : 328 ft. (100 m) (*5) | |
| | Digital output | HDMI/DVI : 66 ft. (20 m) (1080p@60), 39 ft. (12 m) (4K@60) (*4) HDBaseT : 328 ft. (100 m) (*5) | |
| Control | RS-232C | 1 port/captive screw (3-pin), full duplex, up to 115.2 kbps | |
| | LAN | 1 port/RJ-45 10Base-T/100Base-TX/1000Base-T (Auto Negotiation), Auto MDI/MDI-X | |
| Functions | | DDC buffer, Connection Reset pass-through (*6) | |
| General | AC adapter | Input : 100 - 240 VAC ±10%, 50 Hz/60 Hz ±3 Hz Output : DC 5 V 3 A (A dedicated AC adapter is provided) | |
| | Power consumption | About 7 Watts | About 7 Watts |
| | Dimensions | 4.2 (W) × 1.1 (H) × 3.9 (D)" (106 (W) × 28 (H) × 100 (D) mm) (Excluding connectors and the like) | |
| | Weight | 0.9 lbs. (0.4 kg) | 0.9 lbs. (0.4 kg) |
| | Temperature | Operating : 32°F to 104°F (0°C to +40°C) Storage : -4°F to +176°F (-20°C to +80°C) | |
| | Humidity | Operating/Storage: 20% to 90% (Non Condensing) | |

- *1 Required to be used the transmitter and receiver together. Since high-speed signal is transmitted, do not install the transmitter and receiver in an electrically noisy environment. Especially, use of a high-output radio transmission device near the HDC-S may interfere with or interrupt video and or audio signals.
- *2 HEC or ARC is not supported. CEC from a source device to sink device is not supported.
- *3 RJ-45 (HDBaseT connector) is only for extending digital video and audio signals over a category cable. Do not connect to a connector having LAN functionality.
- *4 The maximum cable distance varies depending on the connected devices and was measured under following conditions:
 • 1080p@60: When IDK's 24 AWG cable was used and signals of 1080p@60 24 bit/pixel (8 bit/component) was input or output.
 • 4K@60 : When IDK's 18 Gbps supported cable was used and signals of 4K@60 24 bit/pixel (8 bit/component) was input or output.
 The maximum cable distance depends on the connected devices. The distance may not be extended with some device combinations, cabling method, or other manufacturer's cable. Video may be disturbed or may not be output even if signals are within the range mentioned above.
- *5 The maximum transmission distance was obtained when CAT6A (U/FTP) cable was used. 230 ft. (70 m) if IDK's CAT.5E HDC cable is used. The distance may not be extended with some device combinations or cabling methods. Video may be disturbed or may not be output even if signals are within the range mentioned above. T568A or T568B straight.
- *6 The HDC-S passes through the Connection Reset function of the device installed before the HDC-S. If other devices are connected between the HDC-S and the sink device, this feature may be invalid.

7 Troubleshooting

In case the HDC-S does not work correctly, please check the following items first. Also refer to manuals for connected devices as well, since they may possibly be the cause of the problem.

- Are the HDC-S and all devices connected to power and powered on?
- Are signal cables connected correctly?
- Are there any loose or partially mated connections?
- Are the interconnecting cables specified correctly to support adequate bandwidth?
- For 4K format, is an 18 Gbps high-speed cable used?
- Are specifications of connected devices matched to each other?
- Are configuration settings for the connected devices correct?
- Is there any nearby equipment that may cause electrical noise/RF interference?

If additional assistance is required, please perform the following tests and then contact us.

| No. | Checking items | Result |
|-----|---|-----------|
| 1 | The problem occurs at all connectors? | Yes or No |
| 2 | Connect the devices using genuine cables without connecting the HDC-S. The problem still cannot be solved? Please contact us for assistance. | Yes or No |

User Guide of HDC-S01U-T/HDC-S01U-R

Ver.1.0.0

Issued on: 21 June 2021



Headquarters

IDK Corporation
7-9-1 Chuo, Yamato-shi, Kanagawa-pref.
242-0021 JAPAN
TEL: +81-46-200-0764 FAX: +81-46-200-0765

Email: idk_eng@idk.co.jp

URL: www.idkav.com

USA

IDK America Inc.
72 Grays Bridge Road Suite 1-C, Brookfield, CT 06804
TEL: +1-203-204-2445

Email: sales@idkav.com

URL: www.idkav.com

Europe

IDK Europe GmbH
Lise-Meitner-Str. 6, D-40878 Ratingen
TEL: +49-2102-578-301-0

Email: info@idkav.eu

URL: www.idkav.com



Product information Support

Arvanics Corporation
7-9-1 Chuo, Yamato-shi, Kanagawa-pref.
242-0021 JAPAN
TEL: +81-46-259-6920 FAX: +81-46-259-6930

Email: info@arvanics.com

URL: www.arvanics.com

Information in this document is subject to change without notice.

©2021 IDK Corporation, all rights reserved. All trademarks mentioned are the property of their respective owners.